



Nitrogen Dioxide Transmitter

issue date: 2.Mar.2021, document no: SNO-D.DS_v41

Features

- Replaceable 20mm Round Type Electrochemical Cell
- Estimated operating life 2 years, long term output drift <20% each year
- Zero-Span Calibration & Linear output
- NO2 ranges, standard: 5ppm, 10ppm, 20ppm and 30ppm
- NO2 output signal 4-20 mA and 0...10 Vdc
- Operating voltage 24V AC/DC

Options

- Custom design Display
- Modbus / RS485 port
- Relay, 1 or 2 relays, can be set individually
- Buzzer, can be set individually
- PID, RTC and Datalogger advanced options for special applications

Applications

- Vehicle exhaust measuring at garages, auto parks
- Road tunnels,
- Nitrogen dioxide (NO2) is produced mostly by running diesel engines.
- Recommended alarm levels are 2ppm as pre-alarm and 5ppm as alarm.

Ordering Codes

model	mounting type	output 1	output 2	options	advanced options
SNO	W wall	0 no output	0 no output	M modbus	P PID out
	D duct	1 0...10 Vdc	1 0...10 Vdc	D display	T RTC
		2 2...10 Vdc	2 2...10 Vdc	R relay 1x	L Datalogger
		3 0...5 Vdc	3 0...5 Vdc	RR relay 2x	
		4 1...5 Vdc	4 1...5 Vdc	B buzzer	
		5 4...20 mA	5 4...20 mA		

sample order code: SNO.D51 .MD

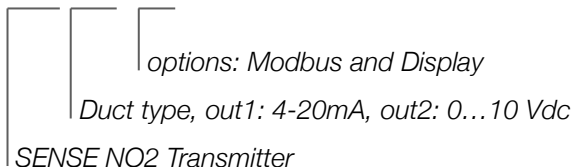

1. ROOM and WALL types are available, please check own datasheets
2. Standart NO2 ranges are field selectable as 5ppm, 10ppm, 20ppm and 30ppm
3. Relay and Buzzer options should have be ordered with Display option
4. For advanced options and special applications, please contact with us info@senseandcontrol.com

General Notes

1. High density of some other gasses may effect the measurements.
2. Observe maximum permissible cable lengths.
3. If cable runs parallel to the mains cable: Use shielded cables.
4. Test only with certified calibration gasses.
5. The cable entry always should have to be pointing downwards.
6. The data indicated under 'Technical Data' apply only to vertically mounted transmitters.
7. Wall/Room type transmitters should have to be mounted in the center of wall but not near to any doors and windows.









Cross Sensitivity

1. The values given are only for information and should not be used as a basis for cross calibration.
2. Cross sensitivities may not be linear and should not be scaled either.
3. Datas based on gassing for 5 minutes using test equipment.

Test Gas	Test Gas Concentration	NO2 Equivalent
Carbon Monoxide	300 ppm	0 ppm
Hydrogen Sulfide	15 ppm	< 1 ppm
Sulphur Dioxide	20 ppm	0 ppm
Hydrogen	200 ppm	0 ppm
Nitric Oxide	50 ppm	< -1 ppm
Carbon Dioxide	5000 ppm	0 ppm
Ammonia	50 ppm	0 ppm
Chlorine	1 ppm	0.5 ppm

DIP Switch Settings

1. Please check if there is any special instruction on the enclosure or inside the cover
2. For any calibration, please choose 1 sec. response time for faster measurements

DIP	Ranges	DIP	Resonse
	5 ppm		1 sec
	10 ppm		5 sec
	20 ppm		30 sec
	30 ppm		60 sec

Electrical Connections

1. Please be sure about current direction for current outputs and polarity for voltage outputs.
2. Relay contact is Normally Open and rating is max. 1A at 230VAC
3. We kindly advise using 24V for avoiding high voltage harmonics and external power relay for bigger loads
4. Please use shielded and twisted paired cables for Modbus connections
5. Please observe RS485 termination rules, max. 32 devices in a single Modbus line

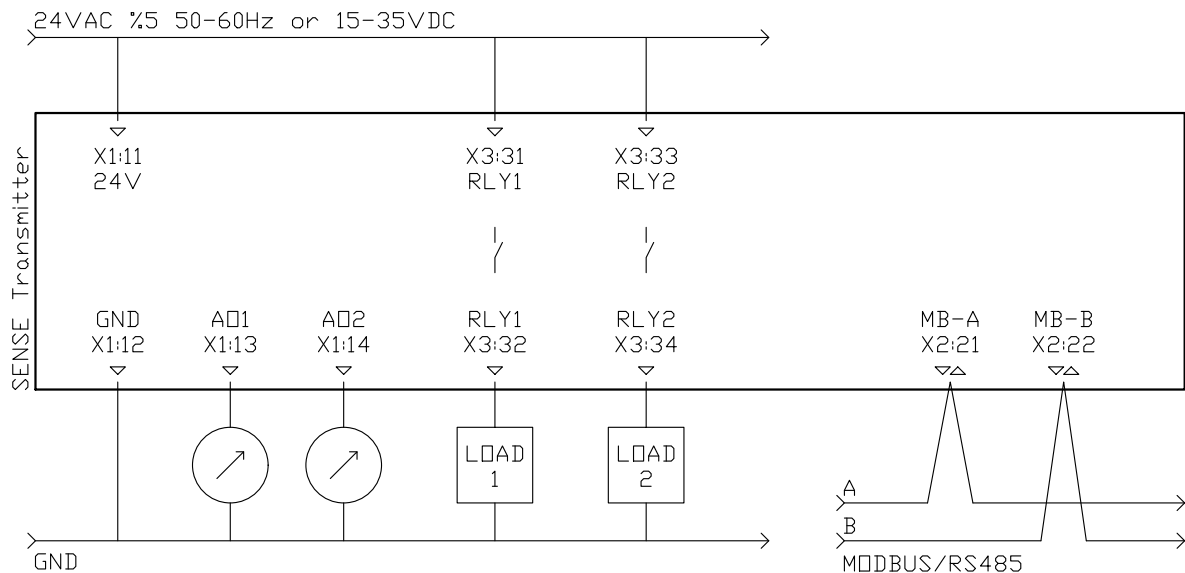

Technical Data

Electrical	Power Supply	AC 24V (\pm %5), 50-60 Hz DC 15...35 V
	Power Consumption	< 2.5 W
Outputs	Current Output	4...20 mA, maximum 500 Ω
	Voltage Output	0...10 Vdc, minimum 1.000 Ω 0...5 Vdc, minimum 1.000 Ω
	Relay Output	max. rating 1A @ 220 Vac
Accuracy	NO2	\pm 3 %
Sensor	t90	< 50 sec.
	life time	> 2 years expected
	drift	< 20% per year
	resolution	0.1 ppm
	repeatability	< \pm 2 %
	baseline	< 0.2 ppm
	Operating Temperature	-20 ...+50°C
Operating Humidity	15...90 %rH	
Operating Pressure	800...1.200 mbar	
General Data	Sensing Element	Electrochemical Cell
	Media	Air or non-aggressive gasses
	Storage Temperature	0 ...+20°C recommended
Ranges	NO2	0...5-10-20-30 ppm
Connections	X1-X2 Terminals	Pluggable screw terminal
	X3 Terminals	Fixed screw terminal
	Cable	maximum 1.5mm ²
	Cable Gland	M16
Protection	SNO.D series	IP41 or NEMA 3
Standards	EMC Directive	EN 61326-1
Dimensions	SNO.D series	98.0 x 81.5 x 45.5 mm, probe \varnothing 30mm x 100mm
Weight Packed	SNO.D series	292 gr

Transmitter Hardware

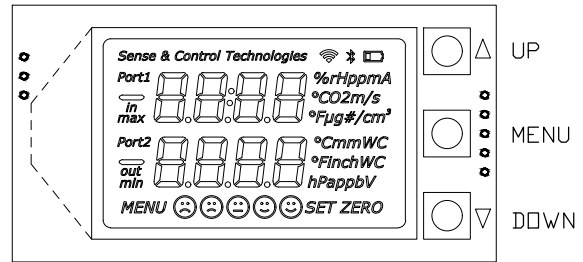
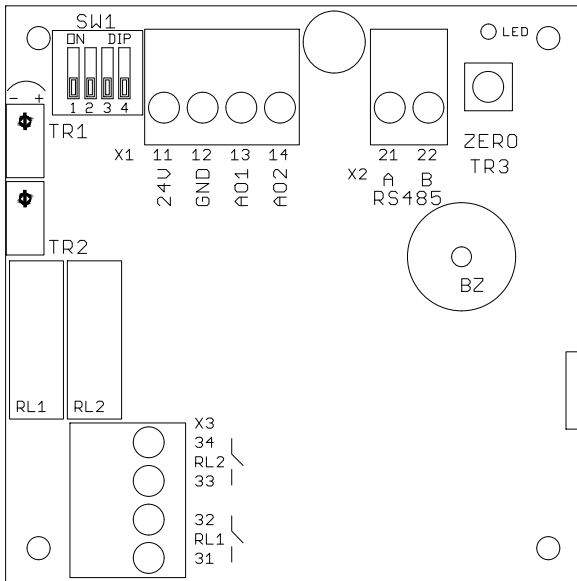

SW1 DIP Switch for configuration range and response time

X1 TERMINAL

11	24V	15...35 Vdc or 24 Vac (± %5, 50-60 Hz)
12	GND	ground for power and reference for outputs
13	AO1	analog output 1
14	AO2	analog output 2

X2 TERMINAL

21	A / RS485	modbus communication positive pair
22	B / RS485	modbus communication negative pair

LED bead LED, periodically lights ON and OFF
modbus communication, blinks when there is a communication

TR1 not used

TR2 not used

ZERO / TR3 not used

RL1 & RL2 relay 1 and relay 2

BZ buzzer

X3 TERMINAL

31	NO - RL1	relay 1 dry contact max. rating 1A @ 220 Vac
32	NO - RL1	relay 1 dry contact max. rating 1A @ 220 Vac
33	NO - RL2	relay 2 dry contact max. rating 1A @ 220 Vac
34	NO - RL2	relay 2 dry contact max. rating 1A @ 220 Vac

Display & Buttons

UP *press for increasing the value or choosing the next parameter*

MENU *press and wait to enter MENU, click to navigate between sub menus one by one*

DOWN *press for decreasing the value or choosing the previous parameter*

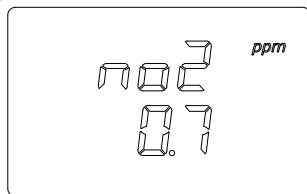

main screen
transmitter is working



keep pressing MENU button until seeing SET
transmitter is not working in MENU mode

Parameters for Relay & Buzzer

Main Screen >>>>> r1 L > r1 H > r1 A > r2 L > r2 H > r2 A > BL > BH > BA > Main Screen

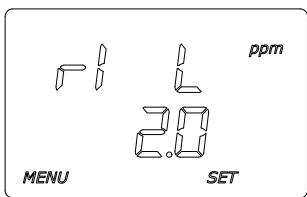

LOW set point for Relay 1

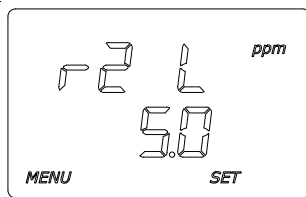

LOW set point for Relay 2

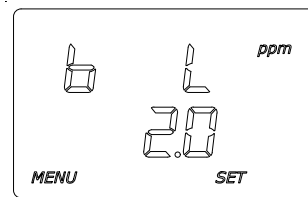

LOW set point for Buzzer

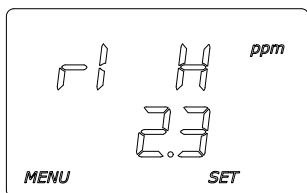

HIGH set point for Relay 1

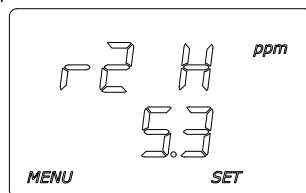

HIGH set point for Relay 2

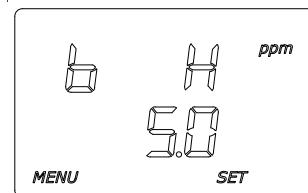

HIGH set point for Buzzer

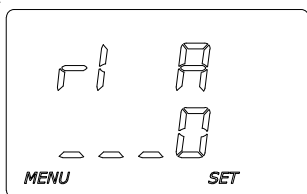

ACTION selection for Relay 1

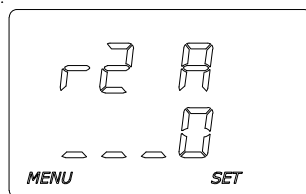

ACTION selection for Relay 2

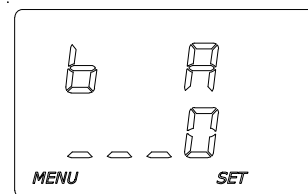

ACTION selection for Buzzer

Actions for Relay & Buzzer



action 0, valid for relays and buzzer,
 relay contact is always OPEN
 buzzer is always SILENCE

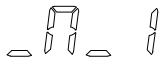

action 1, valid for relays and buzzer,
 relay contact is CLOSED between points, OPEN under LOWpoint and OPEN over HIGHpoint
 buzzer is WARNING between points, SILENCE under LOWpoint and SILENCE over HIGHpoint



action 2, valid for relays and buzzer,
 relay contact is OPEN between points, CLOSED under LOWpoint and OPEN over HIGHpoint
 buzzer is SILENCE between points, WARNING under LOWpoint and SILENCE over HIGHpoint

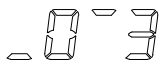

action 3, valid for relays and buzzer,
 relay contact is CLOSED over HIGHpoint, OPEN under LOWpoint, hysteresis between points
 buzzer is WARNING over HIGHpoint, SILENCE under LOWpoint, hysteresis between points

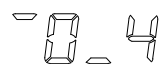

action 4, valid for relays and buzzer,
 relay contact is OPEN over HIGHpoint, CLOSED under LOWpoint, hysteresis between points
 buzzer is SILENCE over HIGHpoint, WARNING under LOWpoint, hysteresis between points



action 5, valid only for buzzer,
 buzzer is WARNING over HIGHpoint, SILENCE under LOWpoint,
 buzzer is WARNING intermittently between points,



action 6, valid only for buzzer,
 buzzer is WARNING under LOWpoint, SILENCE over HIGHpoint,
 buzzer is WARNING intermittently between points,



action 7, valid only for buzzer,
 buzzer is following relay 1 contact,
 buzzer is WARNING when relay 1 contact is CLOSED, SILENCE when the contact is OPEN



action 8, valid only for buzzer,
 buzzer is following relay 2 contact,
 buzzer is WARNING when relay 2 contact is CLOSED, SILENCE when the contact is OPEN

ACTIONS	under LOW	between LOW & HIGH	over HIGH
0 : 0.0.0	Open / Silence	Open / Silence	Open / Silence
1 : 0.1.0	Open / Silence	Closed / Warning	Open / Silence
2 : 1.0.1	Closed / Warning	Open / Silence	Closed / Warning
3 : 0.X.1	Open / Silence	Hysteresis	Closed / Warning
4 : 1.X.0	Closed / Warning	Hysteresis	Open / Silence
5 : 0.-.1	Silence	Pre Alarm	Warning
6 : 1.-.0	Warning	Pre Alarm	Silence
7 : =r1	Silence when RL1 is Open, Warning when RL1 is Closed		
8 : = r2	Silence when RL2 is Open, Warning when RL2 is Closed		

0 : Relay Contact is OPEN, Buzzer is in Silent mode

1 : Relay Contact is CLOSED, Buzzer is in Warning mode

X : Relay Contact is at HYSTERESIS position, OPEN if previous position open, CLOSED if previous position closed

: Buzzer is in HYSTERESIS mode, Silent if previous mode is silent, Warning if previous mode is warning

- : Buzzer is in PRE ALARM mode, Buzzer is warning intermittently

Modbus RS485 Protocol

Default Settings: Modbus ID:1, 9600, 8bit, None, 1. Register Table starts from Base 1.

Use Function 3 for Reading and Function 6 for Writing Holding Registers. Whenever writing to any Modbus Parameter, new parameter is activated instantly and you should have to configure master device according to new parameters. For every reboot/initializing, Modbus is activated with default parameters for 3 seconds. After 3 seconds, Modbus is reconfigured according your parameter settings.

Unlisted registers are for analog output calibrations and some system parameters. Please do not change unlisted registers.

Register	R/W	Range	Description
1	R & W	1...254	Modbus Address
2	R & W	0...4	Baudrate, 0: 9.600, 1: 19.200, 2: 38.400, 3: 57.600, 4: 115.200
3	R & W	0...3	Bit_Parity_Stop, 0: 8bit_None_1, 1: 8bit_None_2, 2: 8bit_Even_1, 3: 8bit_Odd_1
4	R	0...30	NO2 level as ppm x10, divide by 10 for exact value
5	R	0...300	NO2 level as ppm x100, divide by 100 for exact value
6	R	0 or 1	Relay 1, contact position, 0: OFF - Contact is Open, 1: ON - Contact is Closed
7	R	0...1.000	Relay 1, LOW point
8	R	0...1.000	Relay 1, HIGH point
9	R	0...4	Relay 1, ACTION
10	R	0 or 1	Relay 2, contact position, 0: OFF - Contact is Open, 1: ON - Contact is Closed
11	R	0...1.000	Relay 2, LOW point
12	R	0...1.000	Relay 2, HIGH point
13	R	0...4	Relay 2, ACTION
14	R	0 or 1	Buzzer, 0: OK-Silence, 1: PreAlarm - warning intermittently, 2: WARNING continuously
15	R	0...1.000	Buzzer, LOW point
16	R	0...1.000	Buzzer, HIGH point
17	R	0...4	Buzzer, ACTION

Calibration - General Information

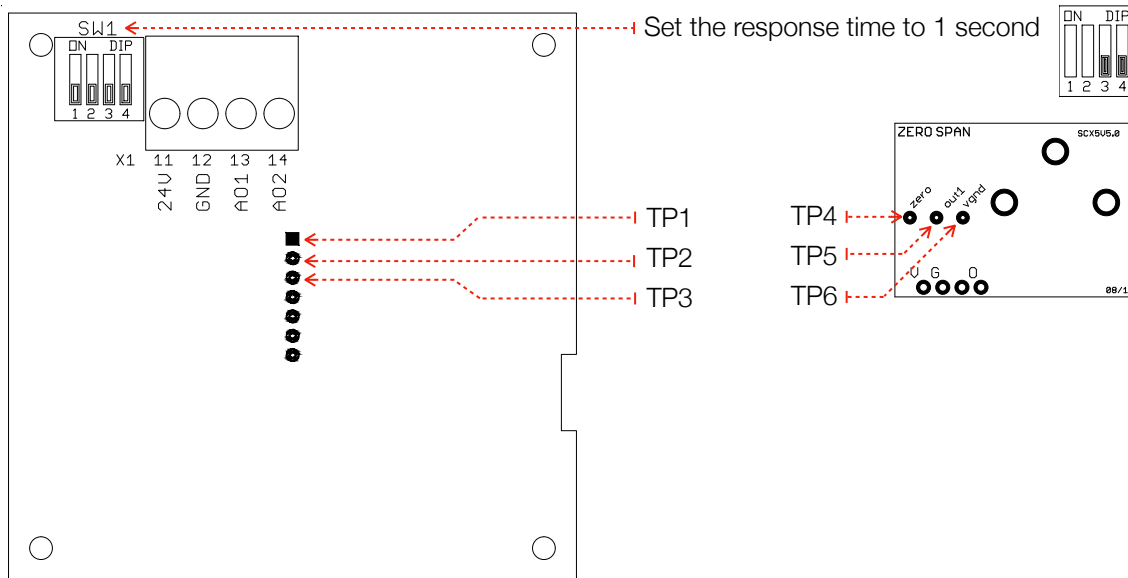

Before the process;

1. Please keep the unit working for minimum 10 minutes at fresh air for settling the baseline.
2. Please use certified calibration NO₂ Test Gasses.
3. Please use a precision multimeter,
 - ⊖ is showing Negative/Reference Point,
 - ⊕ is showing Positive Measurement Point.
4. Set the best range according to calibration gas.
5. Single point calibration is enough for any range.
6. Calibration steps: Check the typical values, Set ZERO, Set SPAN.

Check Typical Values

1. TP2⊖ vs TP1⊕ is about 5 VDC
2. TP2⊖ vs TP6⊕ is about 3.3 VDC
3. TP6⊖ vs TP5⊕ is lower than 5 mV DC

ZERO Calibration

1. Use ZERO Trimmer for setting below values,
2. TP2⊖ vs TP4⊕ should be closest to 3.3 VDC,
3. TP6⊖ vs TP4⊕ should be closest to 0 VDC,
4. TP6⊖ vs TP3⊕ should be closest to 0 VDC,

SPAN Calibration

1. Use SPAN Trimmer for calibration.
2. Before applying the Test Gas, measure output as AO1⊕ vs GND⊖, should be very close to 0ppm.
3. Apply the test gas for min. 1 minute with 0.5 lt/min. flow rate,
4. Start calibration with SPAN trimmer,
5. Analog output should show the test gas concentration value (AO1⊕ vs GND⊖).
6. Applying test gas for 3 minutes is enough for a standard calibration.
7. For best calibration, you can apply the test gas for 5 minutes.
8. Applying the test gas for longer and for many times, reduces the NO₂ Sensing Element life.

Drawings

