



Air Quality Transmitter

issue date: 21.Jun.2021, document no: SAQ-R.DS_v41

Features

- Maintenance free compact MEMS sensor
- VOC (Volatile Organic Compounds): Ethanol, Methane, Carbon Monoxide, Hydrogen, Ammonia
- Automatic Baseline Calculation
- VOC ranges/sensitivity, Low, Medium and High
- Estimated operating life min. 5 years
- VOC output signal 4-20 mA and 0...10 Vdc, others on request
- Operating voltage 24V AC/DC

Options

- Custom design Display
- Modbus / RS485 port
- Relay, 1 or 2 relays, can be set individually
- Buzzer, can be set individually
- PID, RTC and Datalogger advanced options for special applications

Applications

- Air quality applications: measuring VOC concentrations as of odors; tobacco smoke, body odor, or material fumes in cinema/theatre halls, exhibition halls, restaurants, canteens, shopping malls and conference rooms etc
- Ventilation control
- Occupancy level measuring

Ordering Codes

<i>model</i>	<i>mounting type</i>	<i>output 1</i>	<i>output 2</i>	<i>options</i>	<i>advanced options</i>
SAQ	R room	0 no output 1 0...10 Vdc 2 2...10 Vdc 3 0...5 Vdc 4 1...5 Vdc 5 4...20 mA	0 no output 1 0...10 Vdc 2 2...10 Vdc 3 0...5 Vdc 4 1...5 Vdc 5 4...20 mA	M modbus D display R relay 1x RR relay 2x B buzzer	P PID out T RTC L Datalogger

sample order code: SCM.R51 .MD

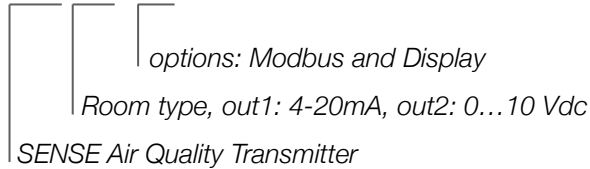









1. WALL and DUCT types are available, please check own datasheets
2. Relay and Buzzer options should have be ordered with Display option
3. For advanced options and special applications, please contact with us info@senseandcontrol.com

General Notes

1. High density of some other gasses may effect the measurements.
2. Observe maximum permissible cable lengths.
3. If cable runs parallel to the mains cable: Use shielded cables.
4. Test only with certified calibration gasses.
5. The cable entry always should have to be pointing downwards.
6. The data indicated under 'Technical Data' apply only to vertically mounted transmitters.
7. Wall/Room type transmitters should have to be mounted in the center of wall but not near to any doors and windows.

DIP Switch Settings

1. Please check if there is any special instruction on the enclosure or inside the cover
2. For any calibration, please do not keep the unit working more than 10 minutes

DIP 1-2	Range/Sensitivity	DIP 3	Baseline	DIP 4	Response
	Low		Auto		60 sec
	Medium		Manual		10 sec
	High				
	Calibration				

Electrical Connections

1. Please be sure about current direction for current outputs and polarity for voltage outputs.
2. Relay contact is Normally Open and rating is max. 1A at 230VAC
3. We kindly advise using 24V for avoiding high voltage harmonics and external power relay for bigger loads
4. Please use shielded and twisted paired cables for Modbus connections
5. Please observe RS485 termination rules, max. 32 devices in a single Modbus line is advised

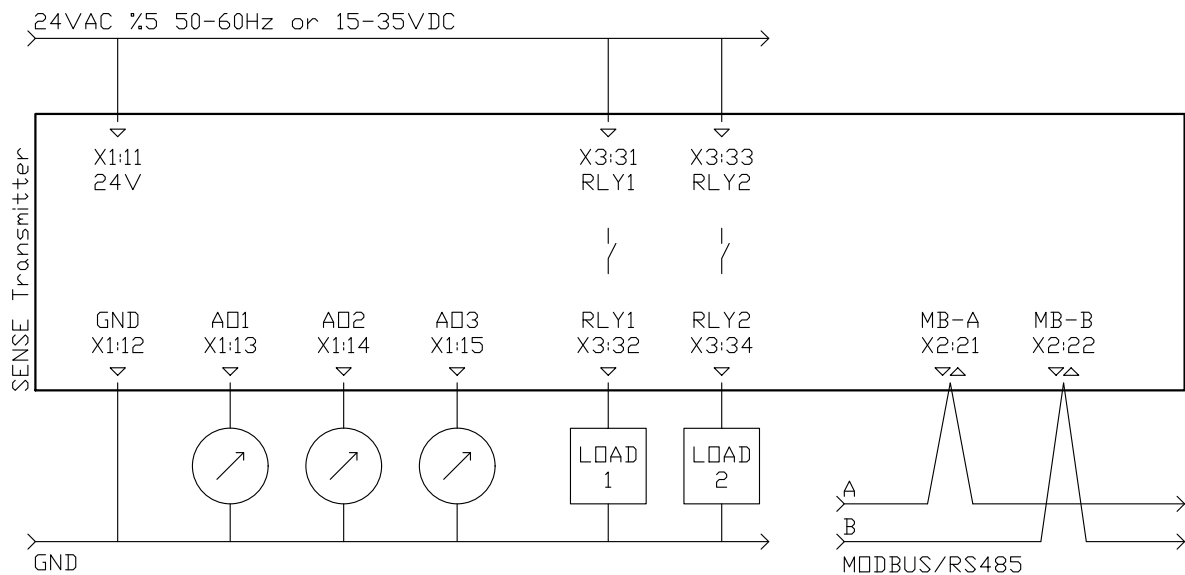

Technical Data

Electrical	Power Supply	AC 24V (\pm 5%), 50-60 Hz DC 15...35 V
	Power Consumption	< 2.5 W
Outputs	Current Output	4...20 mA, maximum 500 Ω
	Voltage Output	0...10 Vdc, minimum 1.000 Ω 0...5 Vdc, minimum 1.000 Ω
	Relay Output	max. rating 1A @ 220 Vac
Accuracy	VOC	\pm 10 % FSO
Sensor	sensing element	MEMS type MOX sensing element
	life time	> 5 years
	drift	< 5% per year
	resolution	0.5%
	repeatability	< \pm 5%
	baseline	10%
	Operating Temperature	-20 ...+50°C
Operating Humidity	15...90 %rH	
Operating Pressure	800...1.200 mbar	
General Data	Sensing Element	Metal oxide
	Media	Air or non-aggressive gasses
	Storage Temperature	0 ...+50°C recommended
Ranges	VOC	Low - Medium - High as sensitivity
Connections	X1-X2 Terminals	Pluggable screw terminal
	X3 Terminals	Fixed screw terminal
	Cable	maximum 1.5mm ²
Protection	SAQ.R series	IP41 or NEMA 3
Standards	EMC Directive	EN 61326-1
Dimensions	without relay	86.0 x 86.0 x 20.5 mm
	with relay	86.0 x 86.0 x 30.7 mm
Weight Packed	SAQ.R series	96 gr

Transmitter Hardware

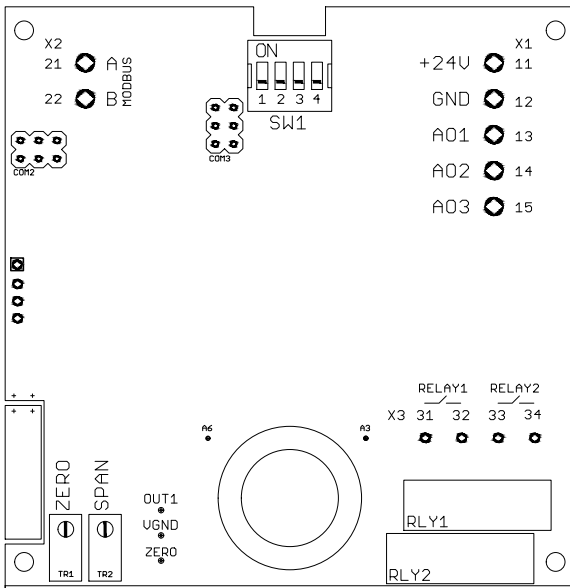

SW1 DIP Switch for configuration range and response time

X1 TERMINAL

11	24V	15...35 Vdc or 24 Vac (± %5, 50-60 Hz)
12	GND	ground for power and reference for outputs
13	AO1	analog output 1
14	AO2	analog output 2
15	AO3	analog output 3

X2 TERMINAL

21	A / RS485	modbus communication positive pair
22	B / RS485	modbus communication negative pair

TR1 not used

TR2 not used

RLY1 & RLY2 relay 1 and relay 2

X3 TERMINAL

31	NO - RL1	relay 1 dry contact max. rating 1A @ 220 Vac
32	NO - RL1	relay 1 dry contact max. rating 1A @ 220 Vac
33	NO - RL2	relay 2 dry contact max. rating 1A @ 220 Vac
34	NO - RL2	relay 2 dry contact max. rating 1A @ 220 Vac

Display & Buttons

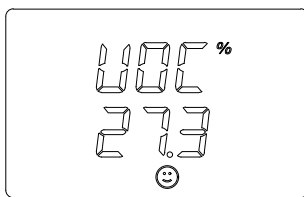
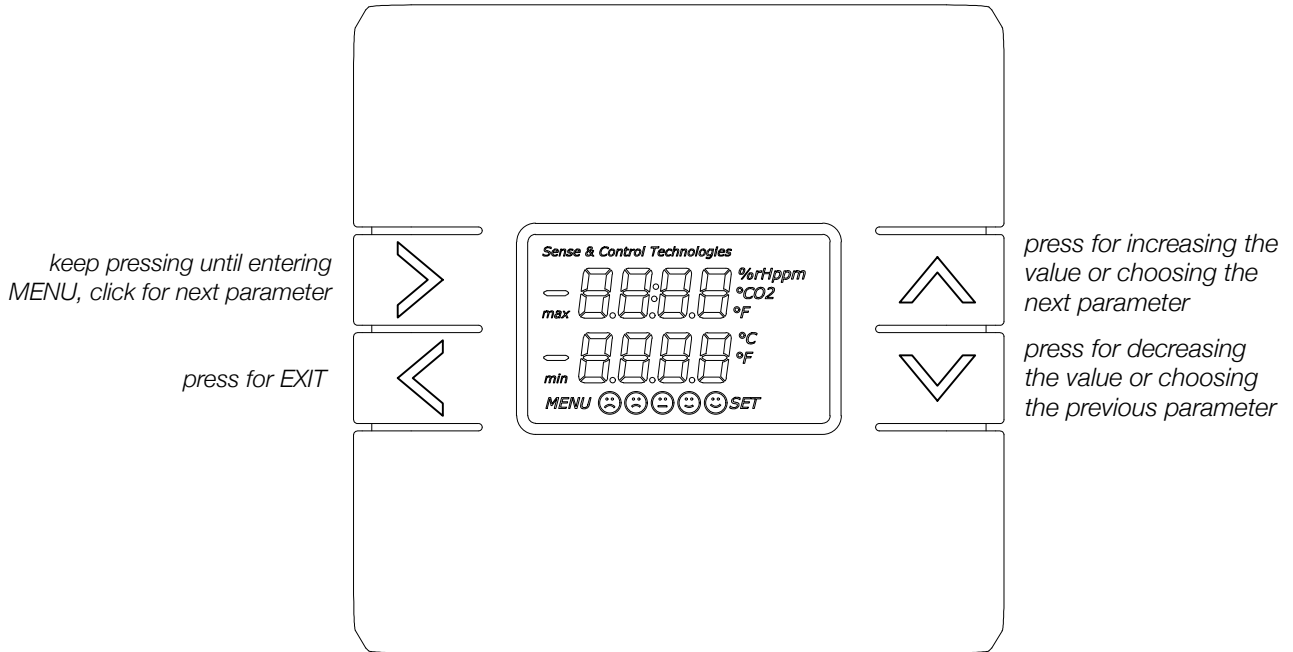

main screen
transmitter is working



keep pressing MENU button until seeing SET
transmitter is not working in MENU mode

Parameters for Relay & Buzzer

Main Screen >>>>> r1 L > r1 H > r1 A > r2 L > r2 H > r2 A > BL > BH > BA > Main Screen

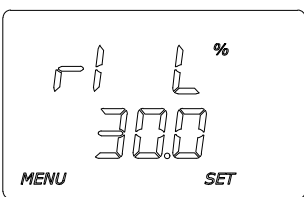

LOW set point for Relay 1

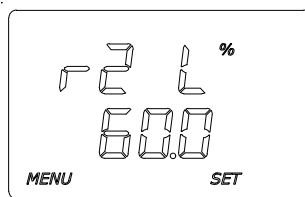

LOW set point for Relay 2

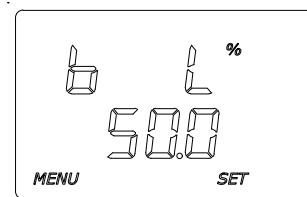

LOW set point for Buzzer

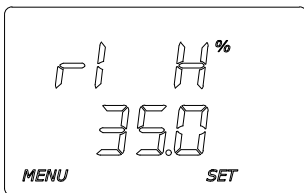

HIGH set point for Relay 1

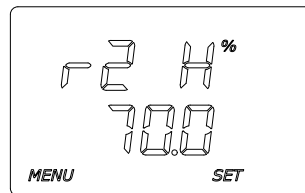

HIGH set point for Relay 2

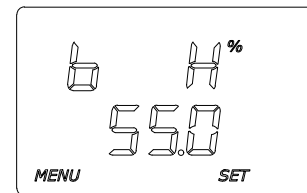

HIGH set point for Buzzer

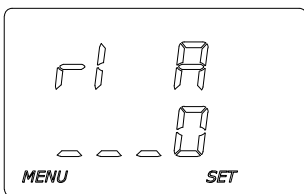

ACTION selection for Relay 1

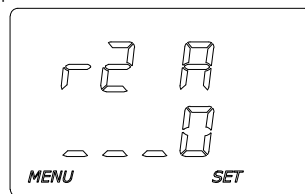

ACTION selection for Relay 2

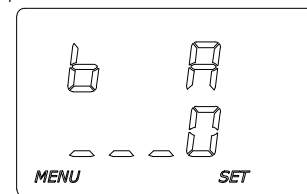

ACTION selection for Buzzer

Actions for Relay & Buzzer



action 0, valid for relays and buzzer,
 relay contact is always OPEN
 buzzer is always SILENCE

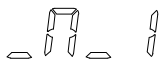

action 1, valid for relays and buzzer,
 relay contact is CLOSED between points, OPEN under LOWpoint and OPEN over HIGHpoint
 buzzer is WARNING between points, SILENCE under LOWpoint and SILENCE over HIGHpoint



action 2, valid for relays and buzzer,
 relay contact is OPEN between points, CLOSED under LOWpoint and OPEN over HIGHpoint
 buzzer is SILENCE between points, WARNING under LOWpoint and SILENCE over HIGHpoint

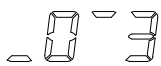

action 3, valid for relays and buzzer,
 relay contact is CLOSED over HIGHpoint, OPEN under LOWpoint, hysteresis between points
 buzzer is WARNING over HIGHpoint, SILENCE under LOWpoint, hysteresis between points

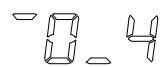

action 4, valid for relays and buzzer,
 relay contact is OPEN over HIGHpoint, CLOSED under LOWpoint, hysteresis between points
 buzzer is SILENCE over HIGHpoint, WARNING under LOWpoint, hysteresis between points



action 5, valid only for buzzer,
 buzzer is WARNING over HIGHpoint, SILENCE under LOWpoint,
 buzzer is WARNING intermittently between points,



action 6, valid only for buzzer,
 buzzer is WARNING under LOWpoint, SILENCE over HIGHpoint,
 buzzer is WARNING intermittently between points,



action 7, valid only for buzzer,
 buzzer is following relay 1 contact,
 buzzer is WARNING when relay 1 contact is CLOSED, SILENCE when the contact is OPEN



action 8, valid only for buzzer,
 buzzer is following relay 2 contact,
 buzzer is WARNING when relay 2 contact is CLOSED, SILENCE when the contact is OPEN

ACTIONS	under LOW	between LOW & HIGH	over HIGH
0 : 0.0.0	Open / Silence	Open / Silence	Open / Silence
1 : 0.1.0	Open / Silence	Closed / Warning	Open / Silence
2 : 1.0.1	Closed / Warning	Open / Silence	Closed / Warning
3 : 0.X.1	Open / Silence	Hysteresis	Closed / Warning
4 : 1.X.0	Closed / Warning	Hysteresis	Open / Silence
5 : 0.-.1	Silence	Pre Alarm	Warning
6 : 1.-.0	Warning	Pre Alarm	Silence
7 : =r1	Silence when RL1 is Open, Warning when RL1 is Closed		
8 : = r2	Silence when RL2 is Open, Warning when RL2 is Closed		

0 : Relay Contact is OPEN, Buzzer is in Silent mode

1 : Relay Contact is CLOSED, Buzzer is in Warning mode

X : Relay Contact is at HYSTERESIS position, OPEN if previous position open, CLOSED if previous position closed

- : Buzzer is in HYSTERESIS mode, Silent if previous mode is silent, Warning if previous mode is warning

- : Buzzer is in PRE ALARM mode, Buzzer is warning intermittently

Modbus RS485 Protocol

Default Settings: Modbus ID:1, 9600, 8bit, None, 1. Register Table starts from Base 1.

Use Function 3 for Reading and Function 6 for Writing Holding Registers. Whenever writing to any Modbus Parameter, new parameter is activated instantly and you should have to configure master device according to new parameters. For every reboot/initializing, Modbus is activated with default parameters for 3 seconds. After 3 seconds, Modbus is reconfigured according your parameter settings.

Unlisted registers are for analog output calibrations and some system parameters. Please do not change unlisted registers.

Register	R/W	Range	Description
1	R & W	1...254	Modbus Address
2	R & W	0...4	Baudrate, 0: 9.600, 1: 19.200, 2: 38.400, 3: 57.600, 4: 115.200
3	R & W	0...3	Bit_Parity_Stop, 0: 8bit_None_1, 1: 8bit_None_2, 2: 8bit_Even_1, 3: 8bit_Odd_1
4	R	0...1.000	VOC level as %, divide by 10 for exact value
5	R	1...5	VOC level as smiling faces, 1:0-15%, 2:15-35%, 3:35-50%, 4:50-75%, 5:75-100%
6	R	0 or 1	Relay 1, contact position, 0: OFF - Contact is Open, 1: ON - Contact is Closed
7	R	0...1.000	Relay 1, LOW point
8	R	0...1.000	Relay 1, HIGH point
9	R	0...4	Relay 1, ACTION
10	R	0 or 1	Relay 2, contact position, 0: OFF - Contact is Open, 1: ON - Contact is Closed
11	R	0...1.000	Relay 2, LOW point
12	R	0...1.000	Relay 2, HIGH point
13	R	0...4	Relay 2, ACTION
14	R	0 or 1	Buzzer, 0: OK-Silence, 1: PreAlarm - warning intermittently, 2: WARNING continuously
15	R	0...1.000	Buzzer, LOW point
16	R	0...1.000	Buzzer, HIGH point
17	R	0...4	Buzzer, ACTION

Calibration - General Information

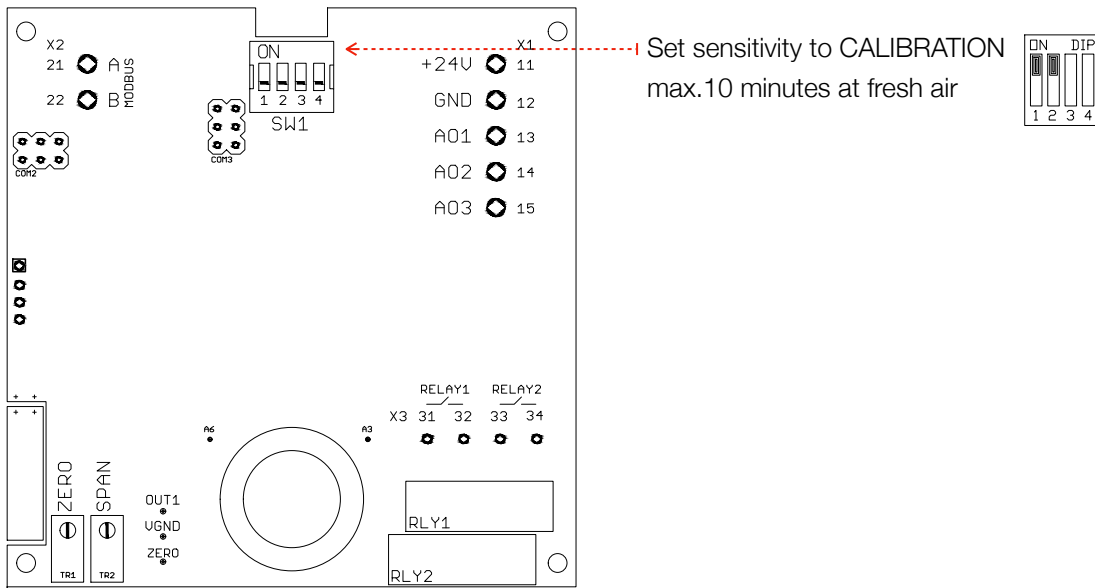

1. Please keep the unit working for minimum 10 minutes at fresh air.
2. Set sensitivity to Calibration Mode.
3. Keep the unit working for between 8-10 minutes at fresh air.
4. Do not forget the unit at calibration mode, do not keep working at calibration mode more than 10 minutes.
5. Change sensitivity setting for settling to HIGH, MEDIUM or LOW.

Smiling Faces

Faces are showing the Air Quality Levels as below:

1. Best % 0 - 15
2. Good %15 - 35
3. Fair %35 - 50
4. Bad %50 - 75
5. Worst %75 - 100

