

Indoor Air Quality VOC Index Transmitter

issue date: 21.Nov.2023, document no: SVI-W.DS_v10

Features

- Maintenance-free compact MEMS sensor
- VOC Index from 0 to 500
- Automatic Baseline Calculation
- VOC output signal 4-20 mA and 0...10 Vdc, others on request
- Operating voltage 24V AC/DC

Options

- Display
- Modbus / RS485 communication
- 1 or 2 Relays, can be set individually
- Buzzer, can be set individually

Applications

- Air quality applications: measuring VOC concentrations as of odors; tobacco smoke, body odor, or material fumes in cinema/theatre halls, exhibition halls, restaurants, canteens, shopping malls and conference rooms etc
- Ventilation control
- Occupancy level measuring

Ordering Codes

<i>model</i>	<i>mounting type</i>	<i>output 1</i>	<i>output 2</i>	<i>options</i>
SVI	W wall	0 no output 1 0...10 Vdc 2 2...10 Vdc 3 0...5 Vdc 4 1...5 Vdc 5 4...20 mA	0 no output 1 0...10 Vdc 2 2...10 Vdc 3 0...5 Vdc 4 1...5 Vdc 5 4...20 mA	M modbus D display R relay 1x RR relay 2x B buzzer

sample order code: SVI.W51 .MD

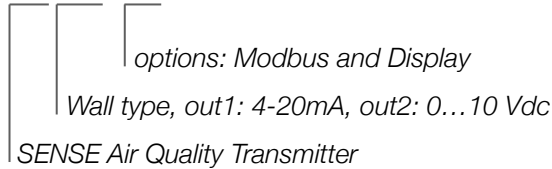





1. ROOM and DUCT types are available, please check own datasheets
2. Relay and Buzzer options should have be ordered with Display option
3. For advanced options and special applications, please contact with us info@senseandcontrol.com

General Notes

1. High density of humidity may effect the measurements.
2. Observe maximum permissible cable lengths.
3. If cable runs parallel to the mains cable: Use shielded cables.
4. Test only with certified calibration gasses.
5. The cable entry always should have to be pointing downwards.
6. The data indicated under 'Technical Data' apply only to vertically mounted transmitters.
7. Wall/Room type transmitters should have to be mounted in the center of wall but not near to any doors and windows.

DIP Switch Settings

1. For units that do not have DIP Switch, the range is fixed as 0...500 VOC Index
2. Please check if there is any special instruction on the enclosure or inside the cover
3. The response is fixed as 1 second for VOC Index calculations

DIP 1-2	Range
	0...500
	0...400
	0...300
	0...200

Electrical Connections

1. Please be sure about the direction of current outputs and the polarity of voltage outputs.
2. Relay contact is Normally Open and rating is max. 1A at 230VAC
3. We kindly advise using 24V for avoiding high voltage harmonics and external power relay for bigger loads
4. Please use shielded and twisted paired cables for Modbus connections
5. Please observe RS485 termination rules, max. 32 devices in a single Modbus line

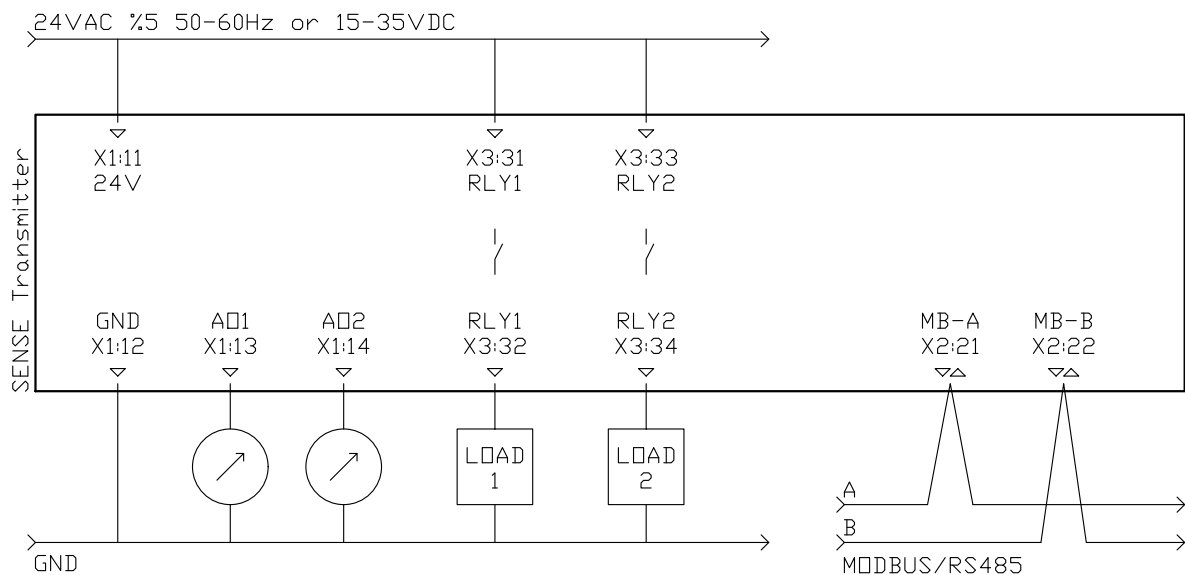

Technical Data

Electrical	Power Supply	AC 24V (\pm %5), 50-60 Hz DC 15...35 V
	Power Consumption	< 2.5 W
Outputs	Current Output	4...20 mA, maximum 500 Ω
	Voltage Output	0...10 Vdc, minimum 1.000 Ω 0...5 Vdc, minimum 1.000 Ω
	Relay Output	max. rating 1A @ 220 Vac
Accuracy	VOC	\pm 15 VOC Index, device to device
Sensor	sensing element	MEMS type MOX sensing element
	lifetime	> 10 years estimated
	resolution	1
	repeatability	< \pm 5 VOC Index
	baseline	100
	Operating Temperature	-10 ...+50°C
Operating Humidity	0...90 %rH	
General Data	Sensing Element	Metal oxide
	Media	Air or non-aggressive gasses
	Storage Temperature	5 ...30°C recommended
Connections	X1-X2 Terminals	Pluggable screw terminal
	X3 Terminals	Fixed screw terminal
	Cable	maximum 1.5mm ²
Protection	SVI.W series	IP54 or NEMA 3
Standards	EMC Directive	EN 61326-1
Dimensions	SVI.W series	98.0 x 81.5 x 45.5 mm
Weight Packed	SVI.W series	229 gr

Transmitter Hardware

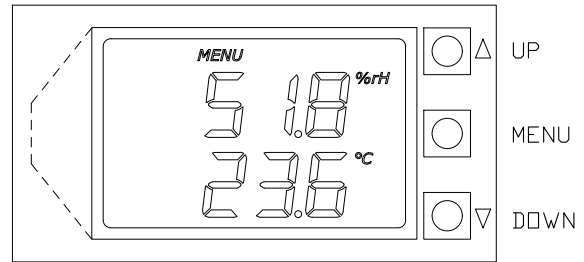
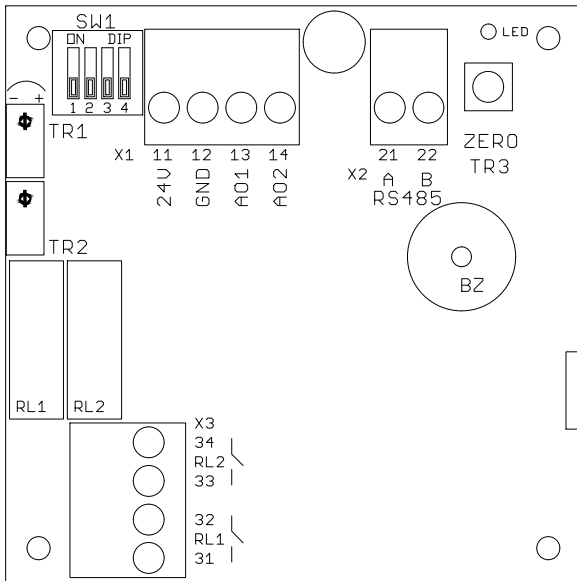

SW1 DIP Switch for configuration range and response time

X1 TERMINAL

11	24V	15...35 Vdc or 24 Vac (± %5, 50-60 Hz)
12	GND	ground for power and reference for outputs
13	AO1	analog output 1
14	AO2	analog output 2

X2 TERMINAL

21	A / RS485	modbus communication positive pair
22	B / RS485	modbus communication negative pair

LED bead LED, periodically lights ON and OFF
modbus communication, blinks when there is a communication

TR1 not used

TR2 not used

ZERO / TR3 not used

RL1 & RL2 relay 1 and relay 2

BZ buzzer

X3 TERMINAL

31	NO - RL1	relay 1 dry contact max. rating 1A @ 220 Vac
32	NO - RL1	relay 1 dry contact max. rating 1A @ 220 Vac
33	NO - RL2	relay 2 dry contact max. rating 1A @ 220 Vac
34	NO - RL2	relay 2 dry contact max. rating 1A @ 220 Vac

Display & Buttons

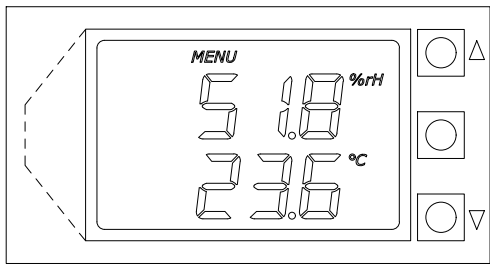

UP *press for increasing the value or choosing the next parameter*
 MENU *press and wait to enter MENU, click to navigate between sub menus one by one*
 DOWN *press for decreasing the value or choosing the previous parameter*

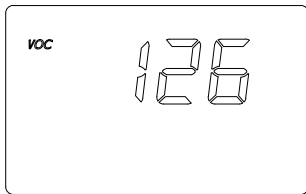

main screen
transmitter is working

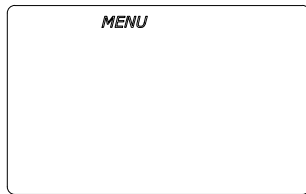

keep pressing MENU button until seeing SET
transmitter is not working in MENU mode

Parameters for Relay & Buzzer

Main Screen >>>>> r1 L > r1 H > r1 A > r2 L > r2 H > r2 A > BL > BH > BA > Main Screen

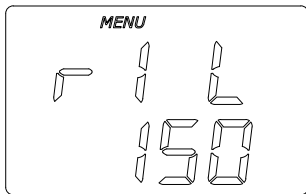

LOW set point for Relay 1

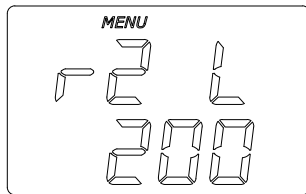

LOW set point for Relay 2

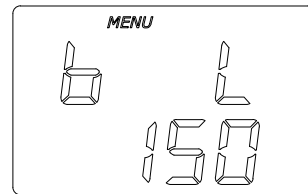

LOW set point for Buzzer

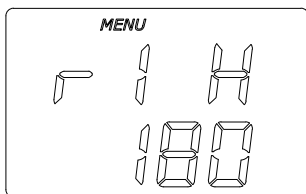

HIGH set point for Relay 1

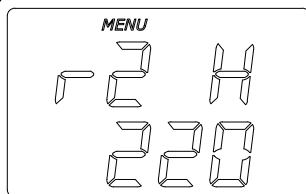

HIGH set point for Relay 2

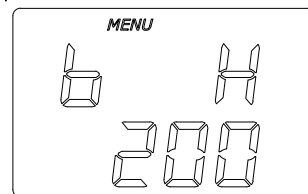

HIGH set point for Buzzer

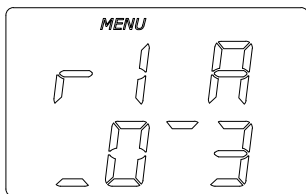

ACTION selection for Relay 1

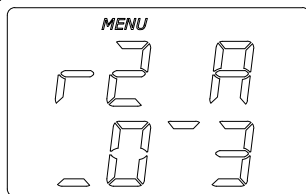

ACTION selection for Relay 2

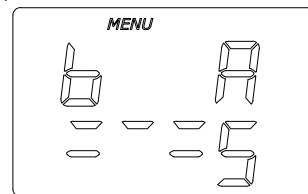

ACTION selection for Buzzer

Actions for Relay & Buzzer



action 0, valid for relays and buzzer,
 relay contact is always OPEN
 buzzer is always SILENCE

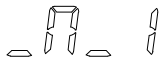

action 1, valid for relays and buzzer,
 relay contact is CLOSED between points, OPEN under LOWpoint and OPEN over HIGHpoint
 buzzer is WARNING between points, SILENCE under LOWpoint and SILENCE over HIGHpoint



action 2, valid for relays and buzzer,
 relay contact is OPEN between points, CLOSED under LOWpoint and OPEN over HIGHpoint
 buzzer is SILENCE between points, WARNING under LOWpoint and SILENCE over HIGHpoint

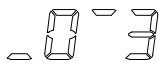

action 3, valid for relays and buzzer,
 relay contact is CLOSED over HIGHpoint, OPEN under LOWpoint, hysteresis between points
 buzzer is WARNING over HIGHpoint, SILENCE under LOWpoint, hysteresis between points

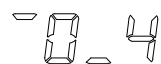

action 4, valid for relays and buzzer,
 relay contact is OPEN over HIGHpoint, CLOSED under LOWpoint, hysteresis between points
 buzzer is SILENCE over HIGHpoint, WARNING under LOWpoint, hysteresis between points



action 5, valid only for buzzer,
 buzzer is WARNING over HIGHpoint, SILENCE under LOWpoint,
 buzzer is WARNING intermittently between points,



action 6, valid only for buzzer,
 buzzer is WARNING under LOWpoint, SILENCE over HIGHpoint,
 buzzer is WARNING intermittently between points,



action 7, valid only for buzzer,
 buzzer is following relay 1 contact,
 buzzer is WARNING when relay 1 contact is CLOSED, SILENCE when the contact is OPEN



action 8, valid only for buzzer,
 buzzer is following relay 2 contact,
 buzzer is WARNING when relay 2 contact is CLOSED, SILENCE when the contact is OPEN

ACTIONS	under LOW	between LOW & HIGH	over HIGH
0 : 0.0.0	Open / Silence	Open / Silence	Open / Silence
1 : 0.1.0	Open / Silence	Closed / Warning	Open / Silence
2 : 1.0.1	Closed / Warning	Open / Silence	Closed / Warning
3 : 0.X.1	Open / Silence	Hysteresis	Closed / Warning
4 : 1.X.0	Closed / Warning	Hysteresis	Open / Silence
5 : 0.-.1	Silence	Pre Alarm	Warning
6 : 1.-.0	Warning	Pre Alarm	Silence
7 : =r1	Silence when RL1 is Open, Warning when RL1 is Closed		
8 : = r2	Silence when RL2 is Open, Warning when RL2 is Closed		

0 : Relay Contact is OPEN, Buzzer is in Silent mode

1 : Relay Contact is CLOSED, Buzzer is in Warning mode

X : Relay Contact is at HYSTERESIS position, OPEN if previous position open, CLOSED if previous position closed

- : Buzzer is in HYSTERESIS mode, Silent if previous mode is silent, Warning if previous mode is warning

- : Buzzer is in PRE ALARM mode, Buzzer is warning intermittently

Modbus RS485 Protocol

Default Settings: Modbus ID:1, 9600, 8bit, None, 1. Register Table starts from Base 1.

Use Function 3 for Reading and Function 6 for Writing Holding Registers. Whenever writing to any Modbus Parameter, a new parameter is activated instantly and you should have to configure the master device according to the new parameters. For every reboot/initializing, Modbus is activated with default parameters for 3 seconds. After 3 seconds, Modbus is reconfigured according to your parameter settings.

Unlisted registers are for analog output calibrations and some system parameters. Please do not change unlisted registers.

ID 254 is the general address. The transmitter replies to address 254 regardless of its own ID. Please use one master and one slave for checking the Modbus address. Also, baudrate and other parameters should match.

Register	R/W	Range	Description
1	R & W	1...254	Modbus Address
2	R & W	0...4	Baudrate, 0: 9.600, 1: 19.200
3	R & W	0...3	Bit_Parity_Stop, 0: 8bit_None_1, 1: 8bit_None_2, 2: 8bit_Even_1, 3: 8bit_Odd_1
4	R	0...500	VOC Index
5	R	0...65.536	VOC Raw Signal
6	R	0 or 1	Relay 1, contact position, 0: OFF - Contact is Open, 1: ON - Contact is Closed
7	R	0...1.000	Relay 1, LOW point
8	R	0...1.000	Relay 1, HIGH point
9	R	0...4	Relay 1, ACTION
10	R	0 or 1	Relay 2, contact position, 0: OFF - Contact is Open, 1: ON - Contact is Closed
11	R	0...1.000	Relay 2, LOW point
12	R	0...1.000	Relay 2, HIGH point
13	R	0...4	Relay 2, ACTION
14	R	0 or 1	Buzzer, 0: OK-Silence, 1: PreAlarm - warning intermittently, 2: WARNING continuously
15	R	0...1.000	Buzzer, LOW point
16	R	0...1.000	Buzzer, HIGH point
17	R	0...4	Buzzer, ACTION

Indoor Air Quality Index & PM2.5

The value 100 refers to the average indoor gas composition over the past 24 h. While values between 100 and 500 indicate a deterioration, values between up to 100 inform about improvement of the air quality. The Gas Index Algorithm is updated every second.

The table below will give you a sense of what levels of VOC Index and PM2.5 are harmful and the appropriate precautions you need to take. It is based on the indoor air quality standards for particle pollution published by the U.S. Environmental Protection Agency.

PM 2.5	IAQ Index	IAQ Category	PM2.5 Health Effect	Precautionary Actions
0.0 ... 12.0	0 ... 50	Good	Little to no risk.	None
12.0 ... 35.4	51 ... 100	Moderate	Unusually sensitive individuals may experience respiratory symptoms.	Unusually sensitive people should consider reducing prolonged or heavy exertion.
35.5 ... 55.4	101...150	Unhealthy for Sensitive Group	Increasing likelihood of respiratory symptoms in sensitive individuals, aggravation of heart or lung disease and premature mortality in persons with cardiopulmonary disease and the elderly.	People with respiratory or heart disease, the elderly and children should limit prolonged exertion.
55.5 ... 150.4	151...200	Unhealthy	Increased aggravation of heart or lung disease and premature mortality in persons with cardiopulmonary disease and the elderly; increased respiratory effects in general population.	People with respiratory or heart disease, the elderly and children should avoid prolonged exertion; everyone else should limit prolonged exertion.
150.5...250.4	201...300	Very Unhealthy	Significant aggravation of heart or lung disease and premature mortality in persons with cardiopulmonary disease and the elderly; significant increase in respiratory effects in general population.	People with respiratory or heart disease, the elderly and children should avoid any outdoor activity; everyone else should avoid prolonged exertion.
250.5 ... 500	301...500	Hazardous	Serious aggravation of heart or lung disease and premature mortality in persons with cardiopulmonary disease and the elderly; serious risk of respiratory effects in general population.	Everyone should avoid any outdoor exertion; people with respiratory or heart disease, the elderly and children should remain indoors.

Source: U.S. Environmental Protection Agency

Drawings

