

## Dual DP Transmitters

issue date: 29.Aug.2024, document no: DS.DDP.r3

### Features

---

- Maintenance free piezoresistive silicon ceramic sensor
- 1 or 2 independent DP sensors
- Independent Analog Outputs for each sensor
- High accuracy,  $\pm 0.25$  %FSS
- Single or Dual versions
- Operating voltages AC 24 V or DC 15...35 V
- Calibrated and temperature compensated measurements
- Output types: 0-10 Vdc, 4-20 mA, 0-5 Vdc, 2-10 Vdc and 1-5 Vdc
- Simple and fast mounting
- Display option
- Modbus/RS485 option
- 2 Relay option
- Buzzer option

### Applications

---

- HVAC supply or extract air measuring,
- Monitoring filters and controlling fans
- Check air flow
- Measuring very low differential pressures
- Clean room applications

## Ordering

sample ordering code:

DDP.4411.MDRRB

options: Modbus, Display, 2x Relay, Buzzer

range1: 2.500pa, range2: 2.500pa, out1: 0-10 Vdc, out2: 0-10 Vdc

Dual DP Transmitter

model	range 1 - Pa	range 2 - Pa	output 1	output 2	options
DDP	0 no	0 no	0 no output	0 no output	M Modbus
	1 ±250	1 ±250	1 0...10 Vdc	1 0...10 Vdc	D Display
	2 1.000	2 1.000	2 2...10 Vdc	2 2...10 Vdc	DD Display with Backlight
	3 ±1.000	3 ±1.000	3 0...5 Vdc	3 0...5 Vdc	R 1 Relay
	4 2.500	4 2.500	4 1...5 Vdc	4 1...5 Vdc	RR 2 Relays
	5 1.000	5 1.000	5 4...20 mA	5 4...20 mA	B Buzzer
	6 6.000	6 6.000			P PID out
	7 ±6.000	7 ±6.000			
	8 ±10.000	8 ±10.000			

## Ordering Notes

1. Ranges stand for the maximum measuring levels
2. Relay, Buzzer and PID options can be ordered with Display option
3. All combinations are possible but some may need minimum order quantity
4. For your special needs, please request from [info@senseandcontrol.com](mailto:info@senseandcontrol.com)

## Ranges & Sub-ranges

1. Each range has own 8 sub-ranges that can be selected by DIP switch
2. For special ranges, please contact with [info@senseandcontrol.com](mailto:info@senseandcontrol.com)

range 1/2- Pa	sub-ranges - Pa
0 no	no
1 ±250	-25...+25, -50...+50, -100...+100, -250...+250, 0...25, 0...50, 0...100, 0...250
2 1.000	0...100, 0...200, 0...300, 0...400, 0...500, 0...600, 0...750, 0...1.000
3 ±1.000	-250...+250, -500...+500, -750...+750, -1.000...+1.000, 0...250, 0...500, 0...750, 0...1.000
4 2.500	0...100, 0...250, 0...500, 0...750, 0...1.000, 0...1.500, 0...2.000, 0...2.500
5 10.000	0...1k, 0...2k, 0...3k, 0...4k, 0...5k, 0...6k, 0...7.5k, 0...10k
6 6.000	0...500, 0...750, 0...1.000, 0...2.000, 0...3.000, 0...4.000, 0...5.000, 0...6.000
7 ±6.000	-1k...+1k, -2k...+2k, -3k...+3k, -6k...+6k, 0...1k, 0...2k, 0...3k, 0...6k
8 ±10.000	-2.5k...+2.5k, -5k...+5k, -7.5k...+7.5k, -10k...+10k, 0...2.5k, 0...5k, 0...7.5k, 0...10k

## Zeroing

1. Press ZERO button for min. 5 seconds
2. With Display models, when you see OK writing, zeroing is finished
3. Without Display models, when LED turns off, zeroing is finished

## General Notes









1. Observe maximum permissible cable lengths.
2. If cable runs parallel to the mains cable: Use shielded cables.
3. The cable entry always should have to be pointing downwards.
4. The data indicated under 'Technical Data' apply only to vertically mounted transmitters.
5. Transmitters should have to be mounted in the center of clean rooms but not near to any doors or windows.

## DIP Switch



1. SW1, channel #1,2,3 selects port 1 sub-ranges
2. SW1, channel #4 selects response time
3. SW2, channel #1,2,3 selects port 2 sub-ranges
4. SW2, channel #4 selects Relay2 source, DP sensor 1 or DP sensor 2

## Sub-Ranges



1. SW1 and SW2 have same sub-ranges
2. Please check the markings on enclosure for any special range

SW	±250 Pa	1.000 Pa	±1.000 Pa	2.500 Pa	10.000 Pa	6.000 Pa	±6.000 Pa	±10.000 Pa
	-25...25	0...100	-250...250	0...100	0...1k	0...500	-1k...1k	-2.5k...2.5k
	-50...50	0...200	-500...500	0...250	0...2k	0...750	-2k...2k	-5k...5k
	-100...100	0...300	-750...750	0...500	0...3k	0...1k	-3k...3k	-7.5k...7.5k
	-250...250	0...400	-1k...1k	0...750	0...4k	0...2k	-6k...6k	-10k...10k
	0...25	0...500	0...250	0...1.000	0...5k	0...3k	0...1k	0...2.5k
	0...50	0...600	0...500	0...1.500	0...6k	0...4k	0...2k	0...5k
	0...100	0...750	0...750	0...2.000	0...7.5k	0...5k	0...3k	0...7.5k
	0...250	0...1.000	0...1.000	0...2.500	0...10k	0...6k	0...6k	0...10k

## Response Time

SW1	Response	
	FAST / 1 sec.	In both cases, FAST or SLOW, - output is mean of latest 10 measurements.  Output is updated: - every 0.1 second in FAST mode - every 0.4 second in SLOW mode
	SLOW / 4 sec.	

## Relay 2 Source Selection

SW2	Source	
	DP 1	Relay 2 feedback source can be selected by SW2/4 - OFF, sensor 1 is the feedback for Relay 2, - ON, sensor 2 is the feedback for Relay 2.
	DP 2	

Relay 1 acts always according to sensor 1 feedback.

## Technical Data

---

Electrical	Power Supply	AC 24V ( $\pm$ 5%), 50-60 Hz DC 15...35 V
	Power Consumption	< 1.5 W
Outputs	Current Output	4...20 mA, maximum 500 $\Omega$
	Voltage Output	0...10 Vdc, minimum 1.000 $\Omega$ 0...5 Vdc, minimum 1.000 $\Omega$
	Resolution	10/12 bit
	Relay Output	max. rating 1A @ 220 Vac
General Data	Sensing Element	Piezoresistive silicon ceramic sensor
	Media	Air or non-aggressive gasses
	Operating Temperature	-25 ...+70°C
	Storage Temperature	-40 ...+85°C
	Tubing	Silicone
Resolution	1 / $\pm$ 250 Pa	1 pascal
	2 / 1.000 Pa	1 pascal
	3 / $\pm$ 1.000 Pa	1 pascal
	4 / 2.500 Pa	1 pascal
	5 / 10.000 Pa	1.5 pascal
	6 / 6.000 Pa	1 pascal
	7 / $\pm$ 6.000 Pa	1 pascal
	8 / $\pm$ 10.000 Pa	1.5 pascal
Accuracy	all models	$\pm$ 0.25 %FSS
Working Pressure	all models	37.500 pascal
Over Pressure	all models	100.000 pascal
Burst Pressure	all models	200.000 pascal
Connections	Terminals	Screw terminal
	Cable	maximum 1.5mm <sup>2</sup>
	Cable Gland	M16
	Pressure Connection	$\varnothing$ 6 mm
Protection	all models	IP54 or NEMA 3S
Standards	EMC Directive	EN 61326-1
	CE Conformity	CE 2020-3
Dimensions	nett	109.5 x 92.5 x 34.0 mm
	packed	113.0 x 96.0 x 38.0 mm
Weight Net	basic models	102 gr.
	full option models	139 gr.
Weight Packed	basic models	120 gr.
	full option models	157 gr.

### Unit Conversions

1.000 Pa = 1 kPa = 10 mbar = 4 inchWC = 102 mmWC = 0,145 ps

# Transmitter Hardware

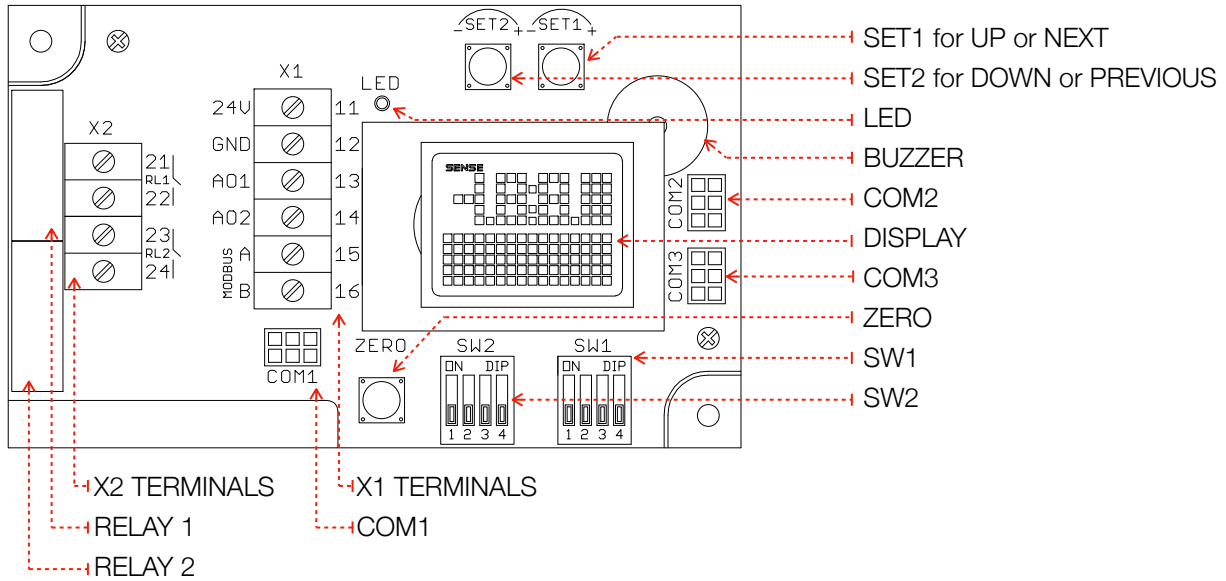

<b>SET1</b>	Main Screen Menu Mode Slide Mode	press min. 5 sec. for entering MENU increase the parameter or next selection next parameter
<b>SET2</b>	Main Screen Menu Mode Slide Mode	press once for entering SLIDE MODE decrease the parameter or previous selection previous parameter
<b>ZERO</b>	Main Screen Menu Mode Slide Mode	press min. 5 sec. for setting ZERO next parameter and finally exit exit from slide mode
<b>LED</b>	Working Modbus	blinks periodically blinks for each Modbus transmitting
<b>BUZZER</b>	alarm pre-alarm =r1 / =r2	sounds continuous sounds intermittent sounds continuous while Relay 1/2 contact is closed
<b>DISPLAY</b>		SENSE's custom dot matrix display, please check page 6 for more information
<b>COM</b>	COM 1 COM 2 COM 3	service port service port service port
<b>SW 1</b>	# 1-2-3 # 4	sub-range selection for DP 1, see page 3 response time selection, see page 3
<b>SW 2</b>	# 1-2-3 # 4	sub-range selection for DP 2, see page 3 source selection for relay 2, see page 3
<b>X1 Terminals</b>	<b>11</b> 24V <b>12</b> GND <b>13</b> AO1 <b>14</b> AO2 <b>15</b> modbus-A <b>16</b> modbus-B	14...35 Vdc or 24 Vac ( $\pm$ %5, 50-60 Hz) ground for power and reference for outputs analog output 1 analog output 2 modbus communication positive pair modbus communication negative pair
<b>X2 Terminals</b>	<b>21-22</b> <b>23-24</b>	relay 1, dry contact, max. rating 1A @ 220 Vac relay 2, dry contact, max. rating 1A @ 220 Vac
<b>Relay 1</b>	normally open	acts always for DP1
<b>Relay 2</b>	normally open	acts for DP1 or DP2 depending on SW2/4 position

## Electrical Connections

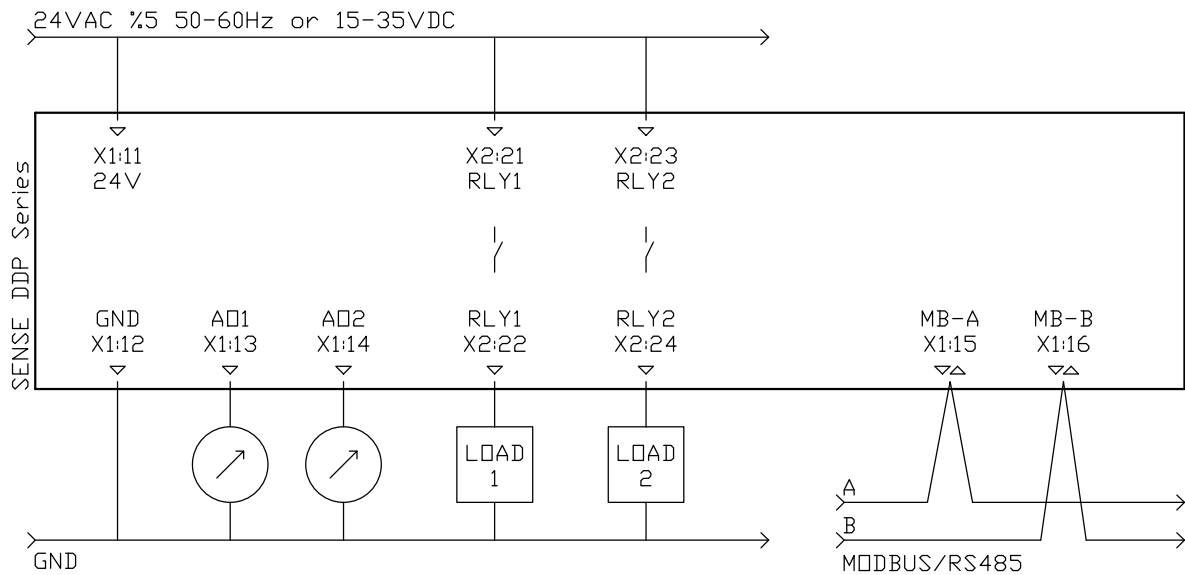

Relay contact rating is max. 1A at 230VAC

We kindly advise using 24V for avoiding high voltage harmonics and external power relay for bigger loads

Please use shielded and twisted paired cables for Modbus connections

## Accessories

Probes and tubes are not included to DP transmitters pack.

Probes and Tubes can be ordered individually or as sets depending on your needs.

<b>Probes</b>	SDP.PR1	probe, 80mm immersion length, 6mm tubing diameter
	SDP.PR2	probe, 120mm immersion length, 6mm tubing diameter
<b>Tubes</b>	SDP.HS1	tube, PVC, 5mm inner diameter, 8mm outer diameter
	SDP.HS2	tube, silicone, 4mm inner diameter, 7mm outer diameter, longer service-life
<b>Sets</b>	SDP.PS11	2x 80mm probe, 2mt PVC tube
	SDP.PS12	2x 80mm probe, 2mt silicone tube
	SDP.PS21	2x 120mm probe, 2mt PVC tube
	SDP.PS22	2x 120mm probe, 2mt silicone tube

# Display & Menu

1. For entering MENU press SET1 button min. 5 sec.
2. ZERO button calls the next parameter
3. SET1 button increases the value or choses the next selection
4. SET2 button decreases the value or choses the previous selection
5. All parameters are listed below, due to options you may not see some of them
6. Any changed parameter or value is set while exiting Menu

Main Screen >> r1L >> r1H >> r1A >> r2L >> r2H >> r2A >> B L >> B H >> B A >> EXIT

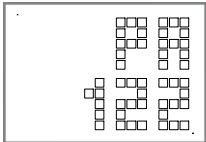

main screen  
for Single DP version

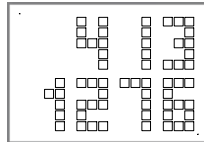

main screen  
for Dual DP version  
upper for DP sensor 1  
lower for DP sensor 2

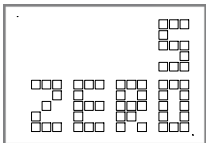

zeroing  
counts down for 5 sec.  
keep pressing ZERO button

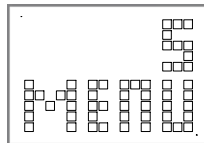

entering MENU  
counts down for 5 sec.  
keep pressing SET1 button

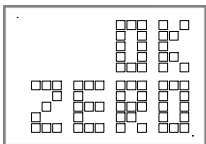

zeroing is OK

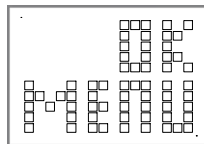

entered to MENU

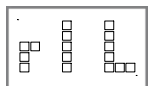

Relay 1, LOW point

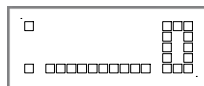

action 0, always OFF

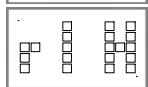

Relay 1, HIGH point

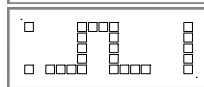

action 1, valid for R1, R2, Buzzer  
ON between LOW and HIGH points

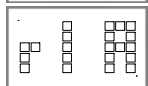

Relay 1, ACTION

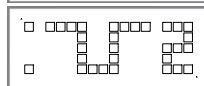

action 2, valid for R1, R2, Buzzer  
OFF between LOW and HIGH points

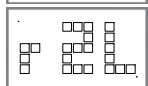

Relay 2, LOW point

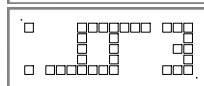

action 3, valid for R1, R2, Buzzer  
ON over HIGH

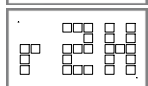

Relay 2, HIGH point

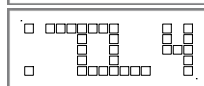

action 4, valid for R1, R2, Buzzer  
ON under LOW

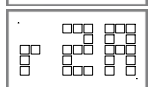

Relay 2, ACTION

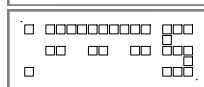

action 5, valid only for Buzzer  
pre-alarm for LOW, alarm for HIGH

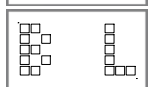

Buzzer, LOW point

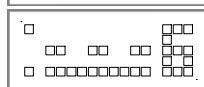

action 6, valid only for Buzzer  
pre-alarm for HIGH, alarm for LOW

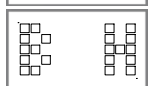

Buzzer, HIGH point

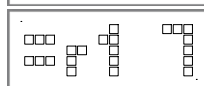

action 7, valid only for Buzzer  
alarm when Relay 1 contact closes

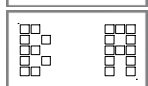

Buzzer, ACTION

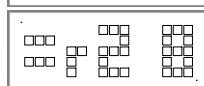

action 8, valid only for Buzzer  
alarm when Relay 2 contact closes

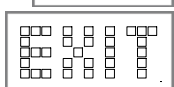

EXIT

## Modbus Protocol

Use Function 3 for Reading and Function 6 for Writing Holding Registers.

Register Table starts from Base 1. Default Settings: Modbus ID:1, 9600, 8bit, None, 1.

Register	R/W	min.	max.	Description
1	R & W	1	254	Modbus Address
2	R & W	0	4	Baudrate, 0: 9.600, 1: 19.200
3	R & W	0	3	Bit_Parity_Stop, 0: 8bit_None_1, 1: 8bit_None_2, 2: 8bit_Even_1, 3: 8bit_Odd_1
4	R	min.Pa	max.Pa	DP-1 measurement as PASCAL
5	R	min.Pa	max.Pa	DP-2 measurement as PASCAL
6	R	0	1	Relay-1, contact position, 0: OFF/Open, 1: ON/Closed
7	R & W	min.Pa	max.Pa	Relay-1, LOW Point
8	R & W	min.Pa	max.Pa	Relay-1, HIGH Point
9	R & W	0	4	Relay-1, Actions
10	R & W	0	1	Relay-2, contact position, 0: OFF/Open, 1: ON/Closed
11	R & W	min.Pa	max.Pa	Relay-2, LOW Point
12	R & W	min.Pa	max.Pa	Relay-2, HIGH Point
13	R & W	0	4	Relay-2, Actions
14	R & W	0	2	Buzzer, 0: OK, 1: Pre-Alarm, 2: Alarm
15	R & W	min.Pa	max.Pa	Buzzer, LOW Point
16	R & W	min.Pa	max.Pa	Buzzer, HIGH Point
17	R & W	0	8	Buzzer, Actions
18	R & W			Blank
19	R & W			Blank
20	R & W			Blank

## Relay & Buzzer Actions/Modes

Action	valid for	under LOW	between LOW - HIGH	over HIGH
0	relay 1-2 & buzzer	open / quiet	open / quiet	open / quiet
1	relay 1-2 & buzzer	open / quiet	closed / alarm	open / quiet
2	relay 1-2 & buzzer	closed / alarm	open / quiet	closed / alarm
3	relay 1-2 & buzzer	open / quiet	hysteresis	closed / alarm
4	relay 1-2 & buzzer	closed / alarm	hysteresis	open / quiet
5	only buzzer	quiet	pre-alarm	alarm
6	only buzzer	alarm	pre-alarm	quiet
7	only buzzer	quiet when relay-1 is open, Alarm when relay-1 is closed		
8	only buzzer	quiet when relay-2 is open, Alarm when relay-2 is closed		



Drawings

