



Nitrogen Dioxide Transmitter

issue date: 2.Mar.2021, document no: SNO-W.DS_v41

Features

- Replaceable 20mm Round Type Electrochemical Cell
- Estimated operating life 2 years, long term output drift <20% each year
- Zero-Span Calibration & Linear output
- NO2 ranges, standard: 5ppm, 10ppm, 20ppm and 30ppm
- NO2 output signal 4-20 mA and 0...10 Vdc
- Operating voltage 24V AC/DC

Options

- Custom design Display
- Modbus / RS485 port
- Relay, 1 or 2 relays, can be set individually
- Buzzer, can be set individually
- PID, RTC and Datalogger advanced options for special applications

Applications

- Vehicle exhaust measuring at garages, auto parks
- Road tunnels,
- Nitrogen dioxide (NO2) is produced mostly by running diesel engines.
- Recommended alarm levels are 2ppm as pre-alarm and 5ppm as alarm.

Ordering Codes

| model | mounting type | output 1 | output 2 | options |
|-------|---------------|--------------|--------------|-------------|
| SNO | W wall | 0 no output | 0 no output | M modbus |
| | D duct | 1 0...10 Vdc | 1 0...10 Vdc | D display |
| | | 2 2...10 Vdc | 2 2...10 Vdc | R relay 1x |
| | | 3 0...5 Vdc | 3 0...5 Vdc | RR relay 2x |
| | | 4 1...5 Vdc | 4 1...5 Vdc | B buzzer |
| | | 5 4...20 mA | 5 4...20 mA | |

sample order code: SNO.W51 .MD

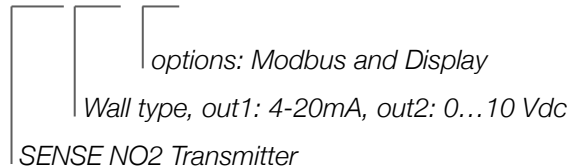

1. ROOM and DUCT types are available, please check own datasheets
2. Standart NO2 ranges are field selectable as 5ppm, 10ppm, 20ppm and 30ppm
3. Relay and Buzzer options should have be ordered with Display option
4. For advanced options and special applications, please contact with us info@senseandcontrol.com

General Notes

1. High density of some other gasses may effect the measurements.
2. Observe maximum permissible cable lengths.
3. If cable runs parallel to the mains cable: Use shielded cables.
4. Test only with certified calibration gasses.
5. The cable entry always should have to be pointing downwards.
6. The data indicated under 'Technical Data' apply only to vertically mounted transmitters.
7. Wall/Room type transmitters should have to be mounted in the center of wall but not near to any doors and windows.









Cross Sensitivity

1. The values given are only for information and should not be used as a basis for cross calibration.
2. Cross sensitivities may not be linear and should not be scaled either.
3. Datas based on gassing for 5 minutes using test equipment.

| Test Gas | Test Gas Concentration | NO2 Equivalent |
|------------------|------------------------|----------------|
| Carbon Monoxide | 300 ppm | 0 ppm |
| Hydrogen Sulfide | 15 ppm | < 1 ppm |
| Sulphur Dioxide | 20 ppm | 0 ppm |
| Hydrogen | 200 ppm | 0 ppm |
| Nitric Oxide | 50 ppm | < -1 ppm |
| Carbon Dioxide | 5000 ppm | 0 ppm |
| Ammonia | 50 ppm | 0 ppm |
| Chlorine | 1 ppm | 0.5 ppm |

DIP Switch Settings

1. Please check if there is any special instruction on the enclosure or inside the cover
2. For any calibration, please choose 1 sec. response time for faster measurements

| DIP | Ranges | DIP | Response |
|---|--------|---|----------|
|  | 5 ppm |  | 1 sec |
|  | 10 ppm |  | 5 sec |
|  | 20 ppm |  | 30 sec |
|  | 30 ppm |  | 60 sec |

Electrical Connections

1. Please be sure about current direction for current outputs and polarity for voltage outputs.
2. Relay contact is Normally Open and rating is max. 1A at 230VAC
3. We kindly advise using 24V for avoiding high voltage harmonics and external power relay for bigger loads
4. Please use shielded and twisted paired cables for Modbus connections
5. Please observe RS485 termination rules, max. 32 devices in a single Modbus line

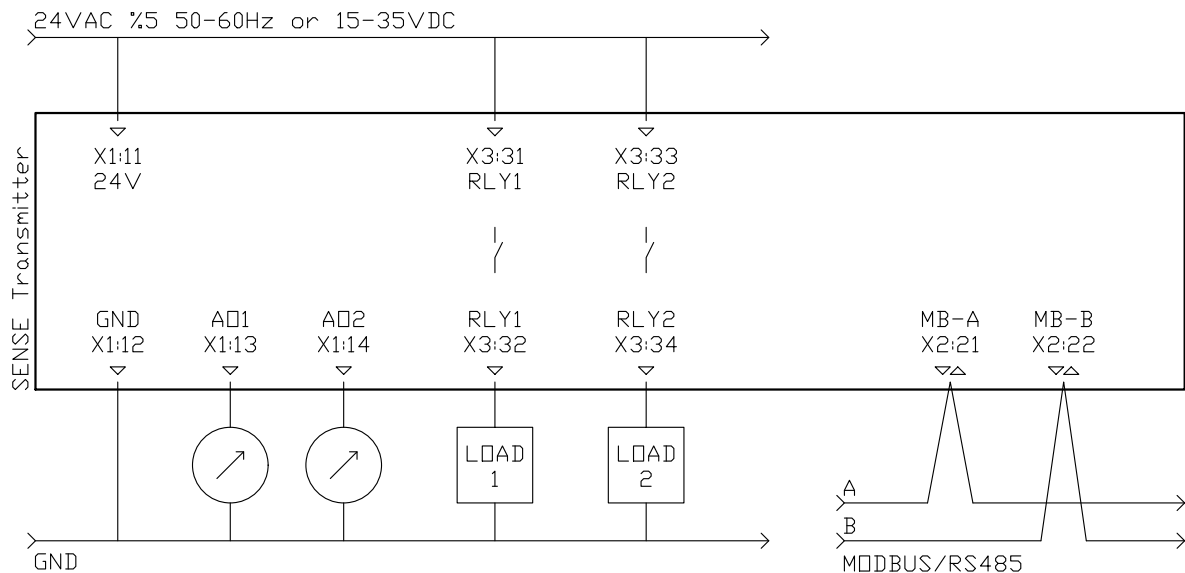

Technical Data

| | | |
|--------------------|-----------------------|---|
| Electrical | Power Supply | AC 24V (\pm %5), 50-60 Hz DC 15...35 V |
| | Power Consumption | < 2.5 W |
| Outputs | Current Output | 4...20 mA, maximum 500 Ω |
| | Voltage Output | 0...10 Vdc, minimum 1.000 Ω 0...5 Vdc, minimum 1.000 Ω |
| | Relay Output | max. rating 1A @ 220 Vac |
| Accuracy | NO2 | \pm 3 % |
| Sensor | t90 | < 50 sec. |
| | life time | > 2 years expected |
| | drift | < 20% per year |
| | resolution | 0.1 ppm |
| | repeatability | < \pm 2 % |
| | baseline | < 0.2 ppm |
| | Operating Temperature | -20 ...+50°C |
| | Operating Humidity | 15...90 %rH |
| Operating Pressure | 800...1.200 mbar | |
| General Data | Sensing Element | Electrochemical Cell |
| | Media | Air or non-aggressive gasses |
| | Storage Temperature | 0 ...+20°C recommended |
| Ranges | NO2 | 0...5-10-20-30 ppm |
| Connections | X1-X2 Terminals | Pluggable screw terminal |
| | X3 Terminals | Fixed screw terminal |
| | Cable | maximum 1.5mm ² |
| | Cable Gland | M16 |
| Protection | SNO.W series | IP41 or NEMA 3 |
| Standards | EMC Directive | EN 61326-1 |
| Dimensions | SNO.W series | 98.0 x 81.5 x 45.5 mm |
| Weight Packed | SNO.W series | 229 gr |

Transmitter Hardware

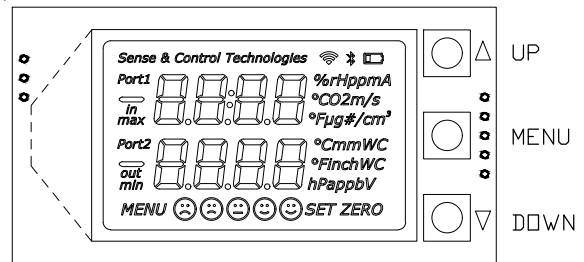
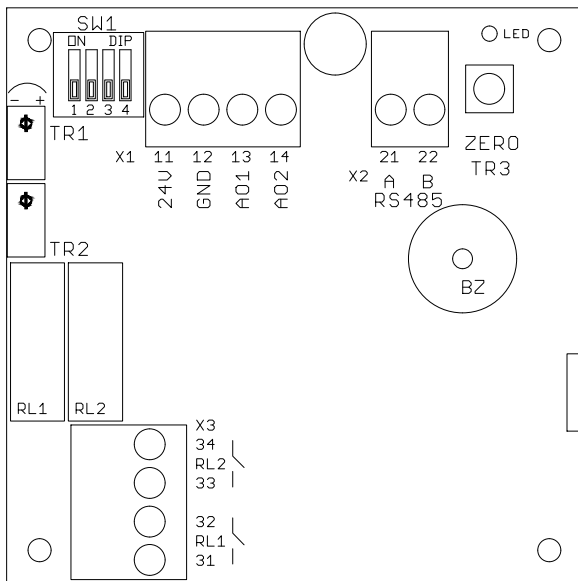

SW1 DIP Switch for configuration range and response time

X1 TERMINAL

| | | |
|-----------|-----|--|
| 11 | 24V | 15...35 Vdc or 24 Vac (± %5, 50-60 Hz) |
| 12 | GND | ground for power and reference for outputs |
| 13 | AO1 | analog output 1 |
| 14 | AO2 | analog output 2 |

X2 TERMINAL

| | | |
|-----------|-----------|------------------------------------|
| 21 | A / RS485 | modbus communication positive pair |
| 22 | B / RS485 | modbus communication negative pair |

LED bead LED, periodically lights ON and OFF
modbus communication, blinks when there is a communication

TR1 not used

TR2 not used

ZERO / TR3 not used

RL1 & RL2 relay 1 and relay 2

BZ buzzer

X3 TERMINAL

| | | |
|-----------|----------|--|
| 31 | NO - RL1 | relay 1 dry contact max. rating 1A @ 220 Vac |
| 32 | NO - RL1 | relay 1 dry contact max. rating 1A @ 220 Vac |
| 33 | NO - RL2 | relay 2 dry contact max. rating 1A @ 220 Vac |
| 34 | NO - RL2 | relay 2 dry contact max. rating 1A @ 220 Vac |

Display & Buttons

UP *press for increasing the value or choosing the next parameter*

MENU *press and wait to enter MENU, click to navigate between sub menus one by one*

DOWN *press for decreasing the value or choosing the previous parameter*

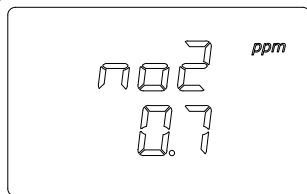

main screen
transmitter is working



keep pressing MENU button until seeing SET
transmitter is not working in MENU mode

Parameters for Relay & Buzzer

Main Screen >>>>> r1 L > r1 H > r1 A > r2 L > r2 H > r2 A > BL > BH > BA > Main Screen

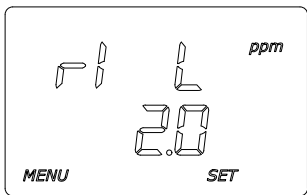

LOW set point for Relay 1

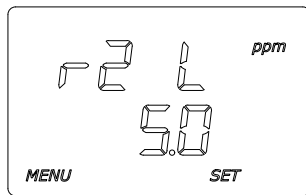

LOW set point for Relay 2

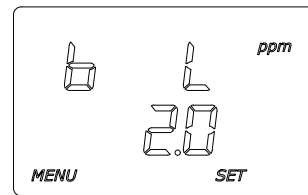

LOW set point for Buzzer

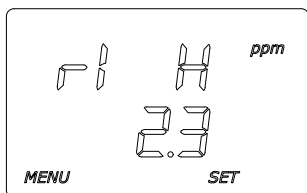

HIGH set point for Relay 1

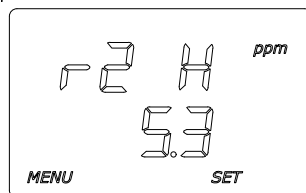

HIGH set point for Relay 2

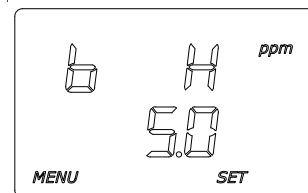

HIGH set point for Buzzer

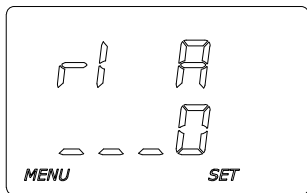

ACTION selection for Relay 1

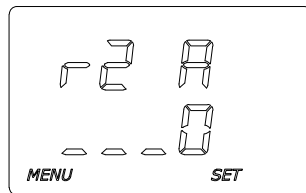

ACTION selection for Relay 2

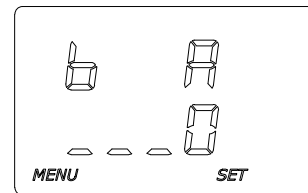

ACTION selection for Buzzer

Actions for Relay & Buzzer



action 0, valid for relays and buzzer,
 relay contact is always OPEN
 buzzer is always SILENCE

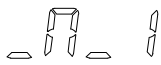

action 1, valid for relays and buzzer,
 relay contact is CLOSED between points, OPEN under LOWpoint and OPEN over HIGHpoint
 buzzer is WARNING between points, SILENCE under LOWpoint and SILENCE over HIGHpoint

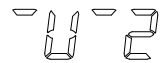

action 2, valid for relays and buzzer,
 relay contact is OPEN between points, CLOSED under LOWpoint and OPEN over HIGHpoint
 buzzer is SILENCE between points, WARNING under LOWpoint and SILENCE over HIGHpoint

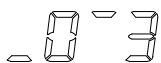

action 3, valid for relays and buzzer,
 relay contact is CLOSED over HIGHpoint, OPEN under LOWpoint, hysteresis between points
 buzzer is WARNING over HIGHpoint, SILENCE under LOWpoint, hysteresis between points

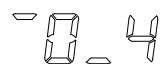

action 4, valid for relays and buzzer,
 relay contact is OPEN over HIGHpoint, CLOSED under LOWpoint, hysteresis between points
 buzzer is SILENCE over HIGHpoint, WARNING under LOWpoint, hysteresis between points



action 5, valid only for buzzer,
 buzzer is WARNING over HIGHpoint, SILENCE under LOWpoint,
 buzzer is WARNING intermittently between points,



action 6, valid only for buzzer,
 buzzer is WARNING under LOWpoint, SILENCE over HIGHpoint,
 buzzer is WARNING intermittently between points,



action 7, valid only for buzzer,
 buzzer is following relay 1 contact,
 buzzer is WARNING when relay 1 contact is CLOSED, SILENCE when the contact is OPEN



action 8, valid only for buzzer,
 buzzer is following relay 2 contact,
 buzzer is WARNING when relay 2 contact is CLOSED, SILENCE when the contact is OPEN

| ACTIONS | under LOW | between LOW & HIGH | over HIGH |
|-----------|--|--------------------|------------------|
| 0 : 0.0.0 | Open / Silence | Open / Silence | Open / Silence |
| 1 : 0.1.0 | Open / Silence | Closed / Warning | Open / Silence |
| 2 : 1.0.1 | Closed / Warning | Open / Silence | Closed / Warning |
| 3 : 0.X.1 | Open / Silence | Hysteresis | Closed / Warning |
| 4 : 1.X.0 | Closed / Warning | Hysteresis | Open / Silence |
| 5 : 0.-.1 | Silence | Pre Alarm | Warning |
| 6 : 1.-.0 | Warning | Pre Alarm | Silence |
| 7 : =r1 | Silence when RL1 is Open, Warning when RL1 is Closed | | |
| 8 : = r2 | Silence when RL2 is Open, Warning when RL2 is Closed | | |

0 : Relay Contact is OPEN, Buzzer is in Silent mode

1 : Relay Contact is CLOSED, Buzzer is in Warning mode

X : Relay Contact is at HYSTERESIS position, OPEN if previous position open, CLOSED if previous position closed

: Buzzer is in HYSTERESIS mode, Silent if previous mode is silent, Warning if previous mode is warning

- : Buzzer is in PRE ALARM mode, Buzzer is warning intermittently

Modbus RS485 Protocol

Default Settings: Modbus ID:1, 9600, 8bit, None, 1. Register Table starts from Base 1.

Use Function 3 for Reading and Function 6 for Writing Holding Registers. Whenever writing to any Modbus Parameter, new parameter is activated instantly and you should have to configure master device according to new parameters. For every reboot/initializing, Modbus is activated with default parameters for 3 seconds. After 3 seconds, Modbus is reconfigured according your parameter settings.

Unlisted registers are for analog output calibrations and some system parameters. Please do not change unlisted registers.

| Register | R/W | Range | Description |
|----------|-------|-----------|--|
| 1 | R & W | 1...254 | Modbus Address |
| 2 | R & W | 0...4 | Baudrate, 0: 9.600, 1: 19.200 |
| 3 | R & W | 0...3 | Bit_Parity_Stop, 0: 8bit_None_1, 1: 8bit_None_2, 2: 8bit_Even_1, 3: 8bit_Odd_1 |
| 4 | R | 0...30 | NO2 level as ppm x10, divide by 10 for exact value |
| 5 | R | 0...300 | NO2 level as ppm x100, divide by 100 for exact value |
| 6 | R | 0 or 1 | Relay 1, contact position, 0: OFF - Contact is Open, 1: ON - Contact is Closed |
| 7 | R | 0...1.000 | Relay 1, LOW point |
| 8 | R | 0...1.000 | Relay 1, HIGH point |
| 9 | R | 0...4 | Relay 1, ACTION |
| 10 | R | 0 or 1 | Relay 2, contact position, 0: OFF - Contact is Open, 1: ON - Contact is Closed |
| 11 | R | 0...1.000 | Relay 2, LOW point |
| 12 | R | 0...1.000 | Relay 2, HIGH point |
| 13 | R | 0...4 | Relay 2, ACTION |
| 14 | R | 0 or 1 | Buzzer, 0: OK-Silence, 1: PreAlarm - warning intermittently, 2: WARNING continuously |
| 15 | R | 0...1.000 | Buzzer, LOW point |
| 16 | R | 0...1.000 | Buzzer, HIGH point |
| 17 | R | 0...4 | Buzzer, ACTION |

Calibration - General Information

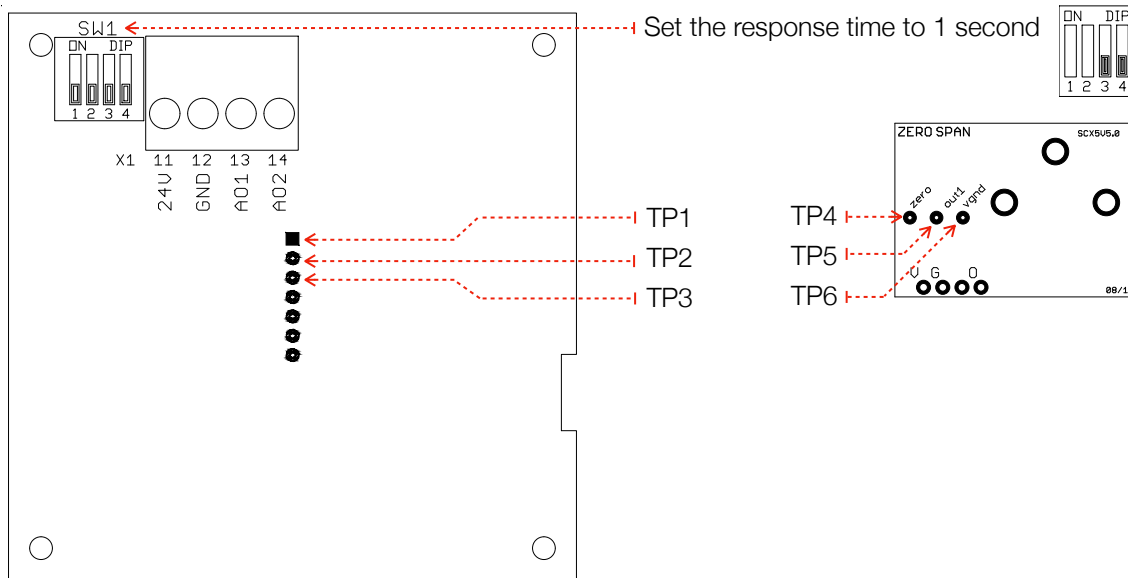

Before the process;

1. Please keep the unit working for minimum 10 minutes at fresh air for settling the baseline.
2. Please use certified calibration NO₂ Test Gasses.
3. Please use a precision multimeter,
 ⊖ is showing Negative/Reference Point,
 ⊕ is showing Positive Measurement Point.
4. Set the best range according to calibration gas.
5. Single point calibration is enough for any range.
6. Calibration steps: Check the typical values, Set ZERO, Set SPAN.

Check Typical Values

1. TP2⊖ vs TP1⊕ is about 5 VDC
2. TP2⊖ vs TP6⊕ is about 3.3 VDC
3. TP6⊖ vs TP5⊕ is lower than 5 mV DC

ZERO Calibration

1. Use ZERO Trimmer for setting below values,
2. TP2⊖ vs TP4⊕ should be closest to 3.3 VDC,
3. TP6⊖ vs TP4⊕ should be closest to 0 VDC,
4. TP6⊖ vs TP3⊕ should be closest to 0 VDC,

SPAN Calibration

1. Use SPAN Trimmer for calibration.
2. Before applying the Test Gas, measure output as AO1⊕ vs GND⊖, should be very close to 0ppm.
3. Apply the test gas for min. 1 minute with 0.5 lt/min. flow rate,
4. Start calibration with SPAN trimmer,
5. Analog output should show the test gas concentration value (AO1⊕ vs GND⊖).
6. Applying test gas for 3 minutes is enough for a standard calibration.
7. For best calibration, you can apply the test gas for 5 minutes.
8. Applying the test gas for longer and for many times, reduces the NO₂ Sensing Element life.

Drawings

